

[www.ortimplant.com](http://www.ortimplant.com)

# ORTHOPAEDIC TRAUMA PRODUCTS

" We produce for your health... "

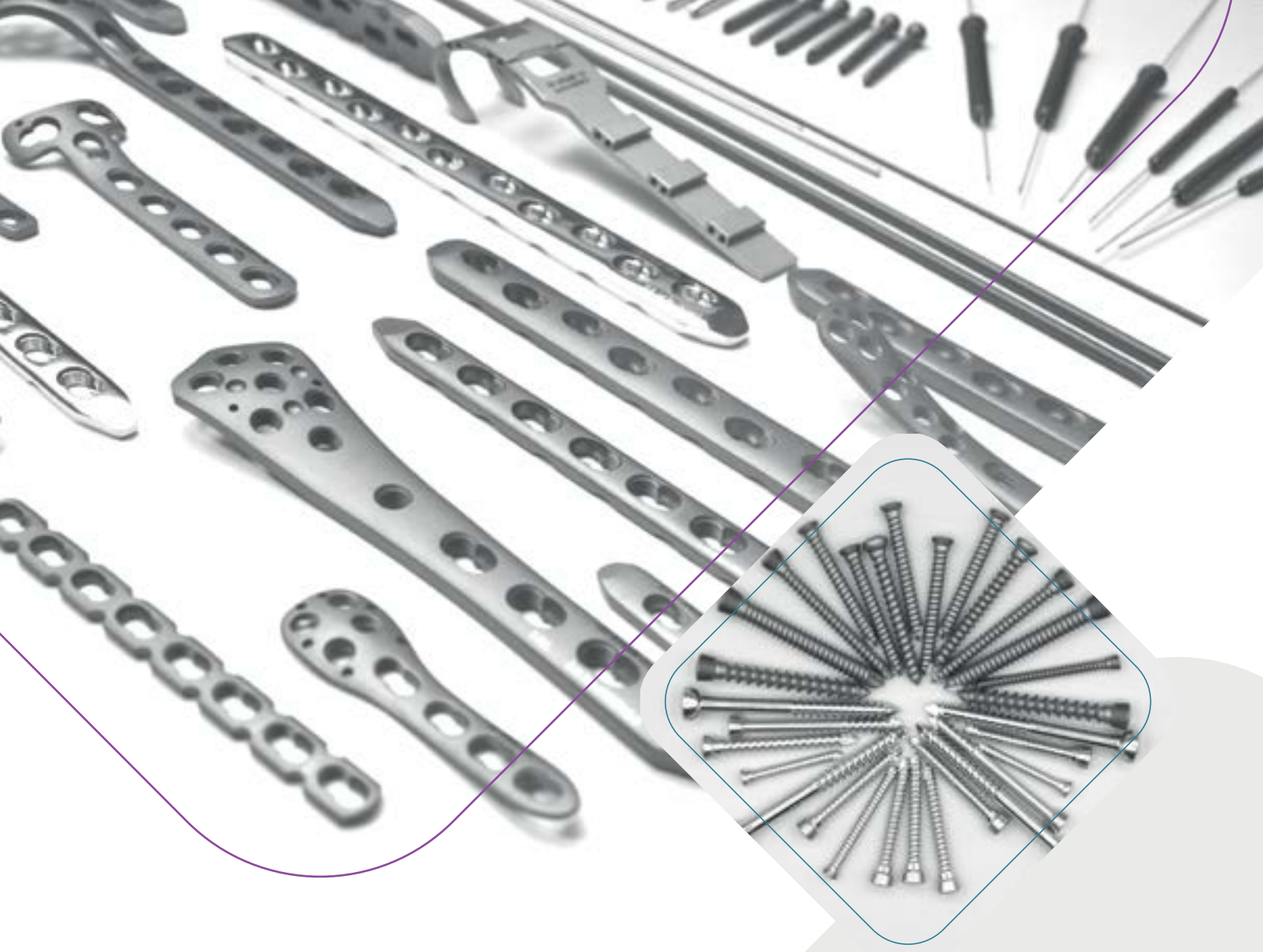



**"We  
produce  
for your  
health..."**

Ortimplant provides a complete platform of trauma & spinal products for upper, lower extremity & spine that covers all the long and small bones injuries for the femur, tibia, fibula clavicle, humerus, radius, ulna, hand & foot bones, spine... etc.

**Plates & Screws  
Small Fragment**

**DHS - DCS Plates**

**Plates & Screw  
Mini Fragment**

**Screws & Splints,  
Chest Wall Plate**

**Pediatric Plates &  
Angled Blade Plates**

## ● TRAUMA PRODUCTS

We produce superior designed and functional products made off ISO 5832 - 1 Stainless steel and ISO 5832 - 3 Titanium high quality raw materials, suitable with human anatomy and meticulous quality standard

## ● STERILIZATION CONTAINERS

We produce aluminum sterilization containers suitable for all surgical sets which are convenient, hygienic, safe & which can be used without wrapping with surgical textiles and which can maintain sterilization safety for a long time

## ● TRAUMA INSTRUMENT SETS

ORTHOPAEDIC surgery instrument sets, including carefully designed aluminum boxes, silicone holders suitable for the placement of the surgical instruments for all ORTHOPAEDIC surgeries, provide great convenience to surgeons during surgery

## ● STERILIZATION BASKETS

We produce perforated stainless steel baskets suitable for all sets of surgical instruments that can be used in sterilization containers or alone

## ● ORTHOPAEDIC SURGICAL INSTRUMENTS

We develop and produce ergonomic, convenient and functional, stainless steel ORTHOPAEDIC surgical instruments which increase the success of surgical procedures

## ● ORTHOPAEDIC STERILIZATION CONTAINERS

Aluminum perforated boxes, screw racks, silicone holders, surgical instrument trays are produced for all surgical instrument sets, which allow the ORTHOPAEDIC surgical instruments to be stored, transported and sterilized by wrapping surgical textile

"With its obsessive Quality policy...."

With its obsessive quality policy and with its open structure to development. Ortimeplant goes on its constitution under today's modern institutional structure

**Trochanteric Plates & Cable System**

**Cannulated Screws**

**Headless, Herbert Screws**

**Intramedullary Nails**

**Elastic Nails**

**Spinal Systems**

**External Fixators**

**Wires, Pins, Staples & Drill Bits**

**Our expert team has years of experience in development of business and strategy..**

From raw materials to services after sales, Ortimeplant considers to apply Total Quality Management System, With respect to this policy Ortimeplant has been certified its Quality with the certificates of CE, ISO 9001 2000, ISO 13485



**Ortimplant**  
**manufactures orthopaedics implants,**  
sterilization containers and accessories in line with world norms  
with its high technologic workshop.

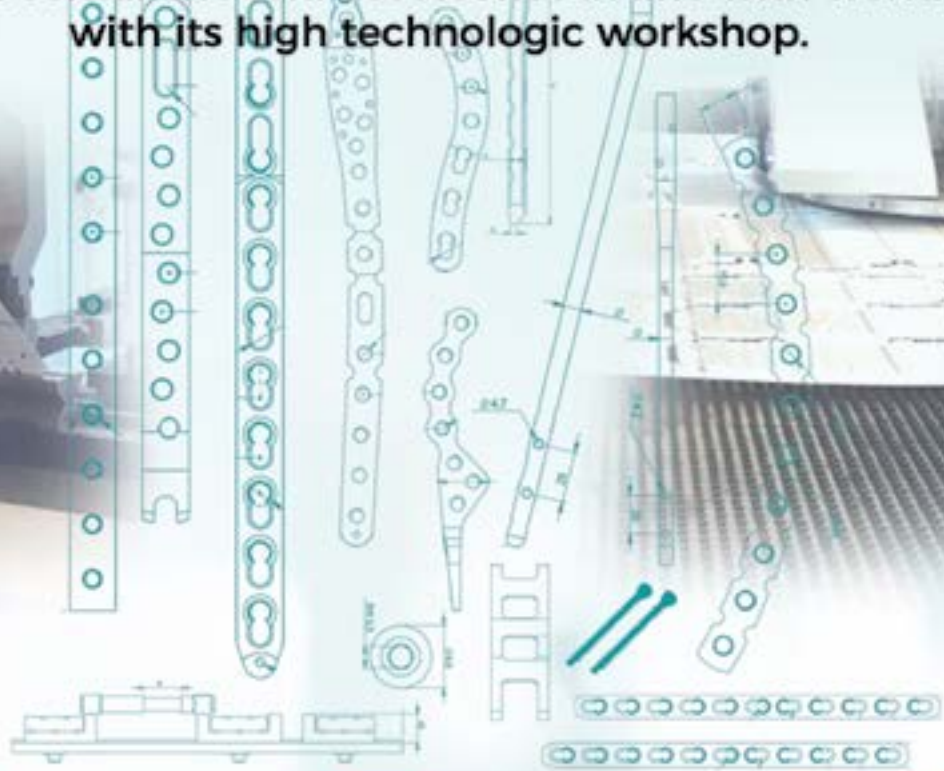

# INDEX

**SPINAL SYSTEMS** .....6 - 12

## **SMALL FRAGMENT PLATES SCREWS**

Locking Plates .....13 - 23

Locking Screws .....24 - 27

Non - Locking Plates .....28 - 34

Non - Locking Screws .....35 - 39

## **LARGE FRAGMENT PLATES SCREWS**

Locking Plates .....56 - 68

Locking Screws .....69 - 73

Non - Locking Plates .....74 - 82

Non - Locking Screws .....83 - 85

## **MINI FRAGMENT PLATES SCREWS**

Locking Plate and Screws .....40 - 52

## **CHEST WALL PLATES SCREWS**

Locking Plate and Screws .....53 - 55

**DHS - DCS PLATES** .....86 - 88

**ANGLED PLATES** .....89 - 94

**CANNULATED SCREWS** .....95 - 101

## **HEADLESS SCREWS**

Headless & Herbert Screws .....102 - 104

## **TROCHANTERIC**

Trochanteric Plate, Cable Grip .....106 - 107

## **INTRAMEDULLARY NAILS**

Humerus Intramedullary Nails .....108 - 110

Femur Intramedullary Nails .....111 - 118

Tibia Intramedullary Nails .....119 - 120

Elastic Intramedullary Nails .....121

## **EXTERNAL FIXATORS**

Dynamic Axial External Fixators .....122 - 130

Mini Rail External Fixators .....131 - 133

Tubular External Fixators .....134 - 137

Hybrid External Fixators .....138 - 142

Circular External Fixators .....143 - 149

Circular Pediatric External Fixators .....150 - 155

## **WIRES, PINS & STAPLES**

Kirschner Wires .....157

Steinmann Pins .....158 - 159

Schanz Screw .....159 - 160

Rush Pin .....160

Staples .....161

Tibial Bolt .....162

Knowless Hip Pin.....162

Drill .....162



# SPINAL SYSTEMS

---

product  
group



Asino Fixed Angle Screw



TI	DIA. x LENGTH (mm)	TI	DIA. x LENGTH (mm)
O8124025	4,0X25	O8126530	6,5X30
O8124030	4,0X30	O8126535	6,5X35
O8124035	4,0X35	O8126540	6,5X40
O8124040	4,0X40	O8126545	6,5X45
O8124525	4,5X25	O8126550	6,5X50
O8124530	4,5X30	O8126555	6,5X55
O8124535	4,5X35	O8126560	6,5X60
O8124540	4,5X40	O8126565	6,5X65
O8124545	4,5X45	O8127030	7,0X30
O8125030	5,0X30	O8127035	7,0X35
O8125035	5,0X35	O8127040	7,0X40
O8125040	5,0X40	O8127045	7,0X45
O8125045	5,0X45	O8127050	7,0X50
O8125050	5,0X50	O8127055	7,0X55
O8125530	5,5X30	O8127060	7,0X60
O8125535	5,5X35	O8127065	7,0X65
O8125540	5,5X40	O8127530	7,5X30
O8125545	5,5X45	O8127535	7,5X35
O8125550	5,5X50	O8127540	7,5X40
O8126030	6,0X30	O8127545	7,5X45
O8126035	6,0X35	O8127550	7,5X50
O8126040	6,0X40	O8127555	7,5X55
O8126045	6,0X45	O8127560	7,5X60
O8126050	6,0X50	O8127565	7,5X65
O8126055	6,0X55		

Asino Fixed - Angle Reduction Screw



TI	DIA. x LENGTH (mm)	TI	DIA. x LENGTH (mm)
O8164025	4,0X25	O8166030	6,0X30
O8164030	4,0X30	O8166035	6,0X35
O8164035	4,0X35	O8166040	6,0X40
O8164040	4,0X40	O8166045	6,0X45
O8164530	4,5X30	O8166050	6,0X50
O8164535	4,5X35	O8166530	6,5X30
O8164540	4,5X40	O8166535	6,5X35
O8164545	4,5X45	O8166540	6,5X40
O8165030	5,0X30	O8166545	6,5X45
O8165035	5,0X35	O8166550	6,5X50
O8165040	5,0X40	O8166555	6,5X55
O8165045	5,0X45	O8167030	7,0X30
O8165530	5,5X30	O8167035	7,0X35
O8165535	5,5X35	O8167040	7,0X40
O8165540	5,5X40	O8167045	7,0X45
O8165545	5,5X45	O8167050	7,0X50
O8165550	5,5X50		

\* DIA. Means DIAMETER

Asino Multi - Axial Screw



TI	DIA. x LENGTH (mm)	TI	DIA. x LENGTH (mm)
O8104025	4,0X25	O8106530	6,5X30
O8104030	4,0X30	O8106535	6,5X35
O8104035	4,0X35	O8106540	6,5X40
O8104040	4,0X40	O8106545	6,5X45
O8104530	4,5X30	O8106550	6,5X50
O8104535	4,5X35	O8106555	6,5X55
O8104540	4,5X40	O8107030	7,0X30
O8104545	4,5X45	O8107035	7,0X35
O8105030	5,0X30	O8107040	7,0X40
O8105035	5,0X35	O8107045	7,0X45
O8105040	5,0X40	O8107050	7,0X50
O8105045	5,0X45	O8107530	7,5X30
O8105530	5,5X30	O8107535	7,5X35
O8105535	5,5X35	O8107540	7,5X40
O8105540	5,5X40	O8107545	7,5X45
O8105545	5,5X45	O8107550	7,5X50
O8105550	5,5X50	O8107555	7,5X55
O8106030	6,0X30	O8107560	7,5X60
O8106035	6,0X35	O8107565	7,5X65
O8106040	6,0X40		
O8106045	6,0X45		
O8106050	6,0X50		
O8106055	6,0X55		

Asino Multi - Axial Reduction Screw



TI	DIA. x LENGTH (mm)	TI	DIA. x LENGTH (mm)
O8144025	4,0X25	O8146030	6,0X30
O8144030	4,0X30	O8146035	6,0X35
O8144035	4,0X35	O8146040	6,0X40
O8144040	4,0X40	O8146045	6,0X45
O8144530	4,5X30	O8146050	6,0X50
O8144535	4,5X35	O8146530	6,5X30
O8144540	4,5X40	O8146535	6,5X35
O8144545	4,5X45	O8146540	6,5X40
O8145030	5,0X30	O8146545	6,5X45
O8145035	5,0X35	O8146550	6,5X50
O8145040	5,0X40	O8147035	7,0X35
O8145045	5,0X45	O8147040	7,0X40
O8145050	5,0X50	O8147045	7,0X45
O8145530	5,5X30		
O8145535	5,5X35		
O8145540	5,5X40		
O8145545	5,5X45		



Asino Cross Link Plate

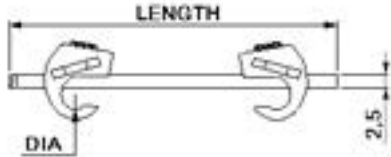

TI	DIA. x LENGTH (mm)
O8482001	6,0X28
O8482002	6,0X48
O8482003	6,0X68
O8482004	6,0X88

6,0 mm Hook

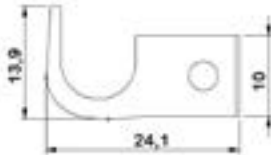

Set Screw

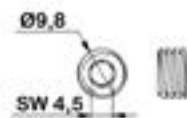

TI	TYPE
O8460001	Pedicle Hook
O8460002	Lamina Hook
O8460003	Transverse Process Hook

TI
O8420600

Lateral Connector 6,0 mm

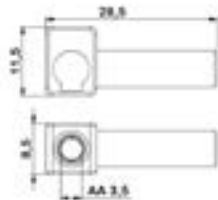

Connector 6,0 mm

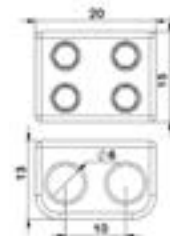

TI
O8426006

TI
O8440810

\* DIA. Means DIAMETER

Rod 6,0 mm

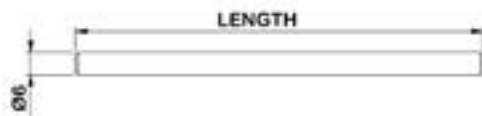

TI	DIA. x LENGTH (mm)
O8001030	6,0X30
O8001035	6,0X35
O8001040	6,0X40
O8001050	6,0X50
O8001060	6,0X60
O8001070	6,0X70
O8001080	6,0X80
O8001090	6,0X90
O8001100	6,0X100
O8001110	6,0X110
O8001250	6,0X250
O8001500	6,0X500

Pediatric Rod 5,0 mm

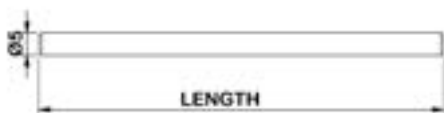

TI	DIA. x LENGTH (mm)
O425 20 060 0060	5,0X60
O425 20 060 0080	5,0X80
O425 20 060 0100	5,0X100
O425 20 060 0110	5,0X110
O425 20 060 0120	5,0X120
O425 20 060 0130	5,0X130
O425 20 060 0140	5,0X140
O425 20 060 0150	5,0X150
O425 20 060 0160	5,0X160
O425 20 060 0180	5,0X180

TI	DIA. x LENGTH (mm)
O425 20 060 0200	5,0X200
O425 20 060 0240	5,0X240
O425 20 060 0260	5,0X260
O425 20 060 0280	5,0X280
O425 20 060 0300	5,0X300
O425 20 060 0320	5,0X320
O425 20 060 0340	5,0X340
O425 20 060 0360	5,0X360
O425 20 060 0380	5,0X380

Anterior Cervical Plate 1

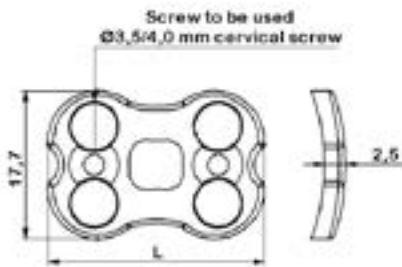

TI	LENGTH (mm)
O433 02 011 0020	26
O433 02 011 0030	30
O433 02 011 0040	33
O433 02 011 0050	36
O433 02 011 0060	39
O433 02 011 0070	42
O433 02 011 0080	45
O433 02 013 0020	48
O433 02 013 0030	51
O433 02 013 0040	54
O433 02 013 0050	57
O433 02 013 0060	61
O433 02 013 0070	64
O433 02 013 0080	70

Anterior Cervical Titanium Screw Plate Locking Apparatus



TI
O442 00 000 0001

Cervical Screw



TI	DIA. x LENGTH (mm)
O6133528	3,5X12
O6133530	3,5X14
O6133532	3,5X16
O6133534	3,5X18
O6133536	3,5X20

Anterior Cervical Plate 2

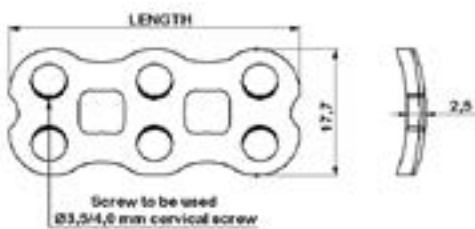

TI	LENGTH (mm)
O433 02 015 0020	25,0
O433 02 015 0030	27,5
O433 02 015 0040	30,0
O433 02 015 0050	32,5
O433 02 015 0060	35,0
O433 02 015 0070	37,5
O433 02 015 0080	40,0
O438 02 002 0070	45,0
O438 02 002 0075	50,0
O438 02 002 0080	55,0
O438 02 002 0085	60,0
O438 02 002 0090	65,0
O438 02 002 0095	70,0
O438 02 002 0100	75,0

\* DIA. Means DIAMETER

Cervical Expansion Head Locking Screw



TI	DIA. x LENGTH (mm)
O400 02 051 0030	4,0X13
O400 02 051 0034	4,0X14
O400 02 051 0036	4,0X15
O400 02 051 0040	4,0X16
O400 02 051 0044	4,0X17
O400 02 052 0025	4,0X18

Head Expansion Aparatus



Anterior Thoracic and Lumbar Plate

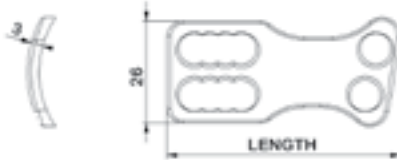

TI	LENGTH (mm)
O400 02 440 0040	60
O400 02 440 0050	65
O400 02 440 0060	70
O400 02 440 0070	75
O400 02 440 0080	80
O400 02 440 0090	85
O400 02 440 0100	90
O400 02 440 0110	100

Anterior Thoracic and Lumbar Bolt



TI	DIA. x LENGTH (mm)
O6134510	6,5X30
O6134512	6,5X35
O6134514	6,5X40
O6134516	6,5X45
O6134518	6,5X50

Anterior Thoracic and Lumbar Screw



TI	DIA. x LENGTH (mm)
O6144014	6,5X30
O6144016	6,5X35
O6144018	6,5X40
O6144020	6,5X45
O6144022	6,5X50



# SMALL FRAGMENT LOCKING PLATES

---

product  
group



## 3,5 mm Clavicle Locking Compression Plate

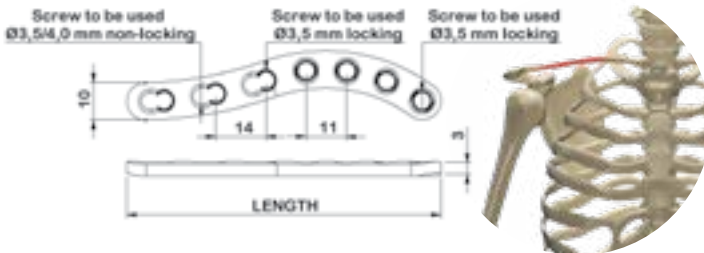

Screw to be used		Thickness (mm)	Width (mm)	
Ø (3,5 / 4,0 mm)		3,0	10,0	
SS	TI	HOLES	SIDE	LENGTH (mm)
O1031906	O1031806	6	Left	70
O1031907	O1031807	7	Left	84
O1031908	O1031808	8	Left	98
O1031909	O1031809	9	Left	112
O1042906	O1042806	6	Right	70
O1042907	O1042807	7	Right	84
O1042908	O1042808	8	Right	98
O1042909	O1042809	9	Right	112

## 3,5 mm Clavicle Hook Locking Plate

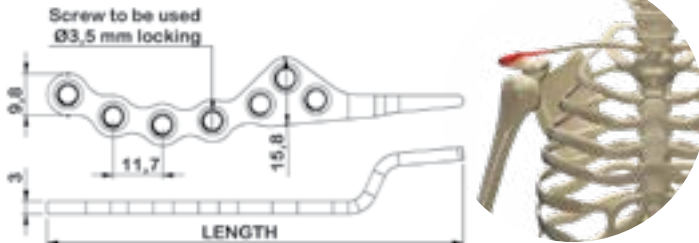

Screw to be used		Thickness (mm)	Width (mm)	
Ø (3,5 mm)		3,0	9,8 - 15,8	
SS	TI	HOLES	SIDE	LENGTH (mm)
O26009141	O26009041	4	Left	63
O26009151	O26009051	5	Left	75
O26009161	O26009061	6	Left	86
O26009171	O26009071	7	Left	97
O26009142	O26009042	4	Right	63
O26009152	O26009052	5	Right	75
O26009162	O26009062	6	Right	86
O26009172	O26009072	7	Right	97

## 2,7 / 3,5 mm Distal Clavicle Locking Compression Plate

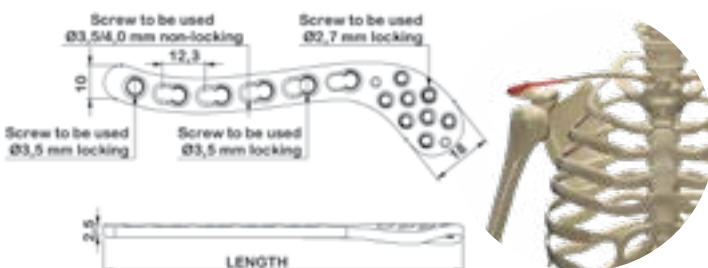

Screw to be used		Thickness (mm)	Width (mm)	
Ø (2,7/3,5/4,0 mm)		2,5	10,0 - 18,0	
SS	TI	HOLES	SIDE	LENGTH (mm)
O5521903	O1021803	3	Left	66,5
O5521904	O1021804	4	Left	78,7
O5521905	O1021805	5	Left	91,1
O5521906	O1021806	6	Left	103,2
O5521907	O1021807	7	Left	113,8
O5522903	O1022803	3	Right	66,5
O5522904	O1022804	4	Right	78,7
O5522905	O1022805	5	Right	91,1
O5522906	O1022806	6	Right	103,2
O5522907	O1022807	7	Right	113,8

3,5 mm Clavicle Reconstruction Locking Compression Plate

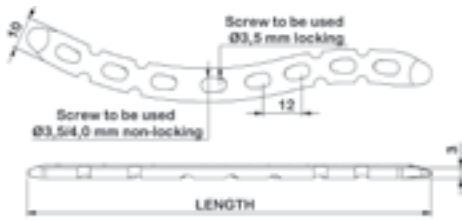

Screw to be used		Thickness (mm)	Width (mm)		
Ø (3,5 / 4,0 mm)		3,0	10,0		
SS	TI	HOLES	SIDE	LENGTH (mm)	
O1531806	O1530806	6	Left	94,3	
O1531807	O1530807	7	Left	107,8	
O1531813	O1530813	8	Left	121	
O1531809	O1530809	9	Left	133	
O1531906	O1530906	6	Right	94,3	
O1531907	O1530907	7	Right	107,8	
O1531913	O1530913	8	Right	121	
O1531910	O1530910	9	Right	133	

3,5 mm Proximal Humerus Locking Compression Plate 1

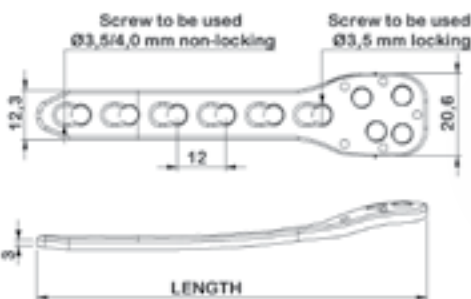

Screw to be used		Thickness (mm)	Width (mm)	
Ø (3,5 / 4,0 mm)		3	12,3 - 20,6	
SS	TI	HOLES	LENGTH (mm)	
O1620903	O1620803	3	61,1	
O1620904	O1620804	4	73,1	
O1620905	O1620805	5	85,1	
O1620906	O1620806	6	97,1	
O1620907	O1620807	7	109,1	
O1620908	O1620808	8	121,1	

3,5 mm Proximal Humerus Locking Compression Plate 2

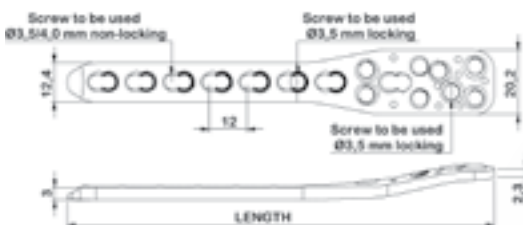

Screw to be used		Thickness (mm)	Width (mm)	
Ø (3,5 / 4,0 mm)		3	12,4 - 20,2	
SS	TI	HOLES	LENGTH (mm)	
O1630903	O1630803	3	87	
O1630904	O1630804	4	99	
O1630905	O1630805	5	111	
O1630906	O1630806	6	123	
O1630907	O1630807	7	135	
O1630908	O1630808	8	147	
O1630909	O1630809	9	159	

3,5 mm Proximal Humerus Locking Compression Plate 3

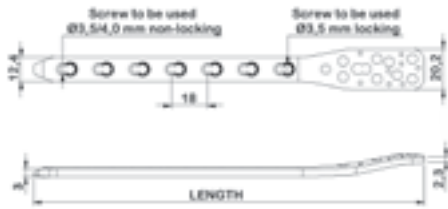

Screw to be used	Thickness (mm)	Width (mm)	
Ø (3,5 / 4,0 mm)	3	12,4 - 20,2	
SS	TI	HOLES	LENGTH (mm)
O1640903	O1640803	3	122
O1640904	O1640804	4	140
O1640905	O1640805	5	158
O1640906	O1640806	6	176
O1640907	O1640807	7	194

3,5 mm Cloverleaf Locking Plate

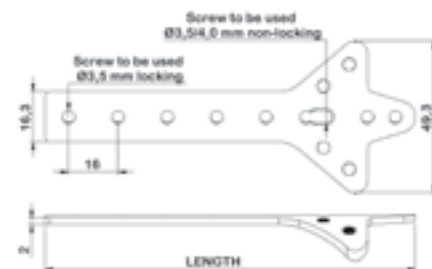

Screw to be used	Thickness (mm)	Width (mm)	
Ø (3,5 / 4,0 mm)	2	16,3 - 49,3	
SS	TI	HOLES	LENGTH (mm)
O101 02 270 0003	O111 02 270 0003	3	88,1
O101 02 270 0004	O111 02 270 0004	4	104,1
O101 02 270 0005	O111 02 270 0005	5	120,1
O101 02 270 0006	O111 02 270 0006	6	136,1
O101 02 270 0007	O111 02 270 0007	7	152,1
O101 02 270 0008	O111 02 270 0008	8	168,1

3,5 mm Distal Lateral Humerus Locking Plate

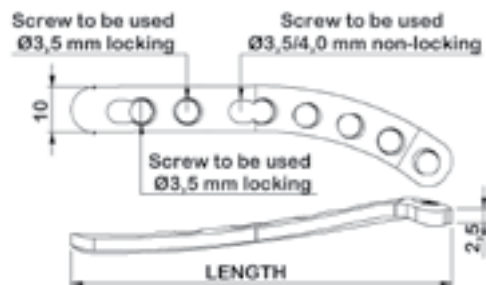

Screw to be used	Thickness (mm)	Width (mm)		
Ø (3,5 / 4,0 mm)	2,5	10,0		
SS	TI	HOLES	SIDE	LENGTH (mm)
O5248105	O5238105	5	Left	56,5
O5248107	O5238107	7	Left	83,5
O5248109	O5238109	9	Left	108,5
O5248111	O5238111	11	Left	133,5
O5248113	O5238113	13	Left	158,5
O5248115	O5238115	15	Left	183,5
O5248205	O5238205	5	Right	56,5
O5248207	O5238207	7	Right	83,5
O5248209	O5238209	9	Right	108,5
O5248211	O5238211	11	Right	133,5
O5248213	O5238213	13	Right	158,5
O5248215	O5238215	15	Right	183,5



2,7 / 3,5 mm Distal Humerus Dorsolateral Locking Plate

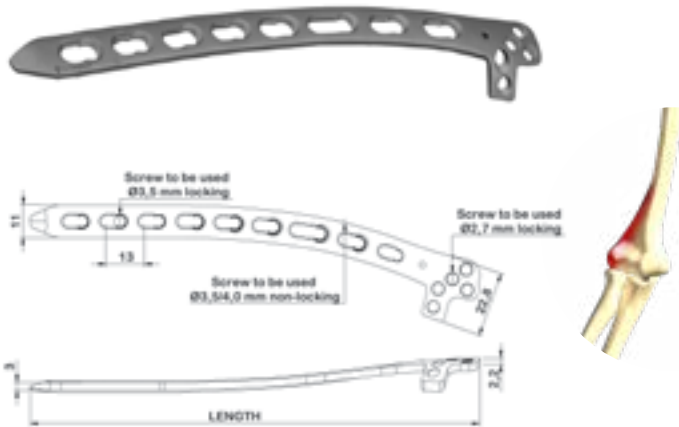

Screw to be used		Thickness (mm)	Width (mm)	
Ø (2,7 / 3,5 / 4,0 mm)		3	11,0 - 22,8	
SS	TI	HOLES	SIDE	LENGTH (mm)
O9248105	O9238105	5	Left	103,9
O9248107	O9238107	7	Left	126,9
O9248109	O9238109	9	Left	152,9
O9248111	O9238111	11	Left	178,9
O9248113	O9238113	13	Left	204,9
O9248205	O9238205	5	Right	103,9
O9248207	O9238207	7	Right	126,9
O9248209	O9238209	9	Right	152,9
O9248211	O9238211	11	Right	178,9
O9248213	O9238213	13	Right	204,9

3,5 mm Distal Medial Humerus Locking Plate 1

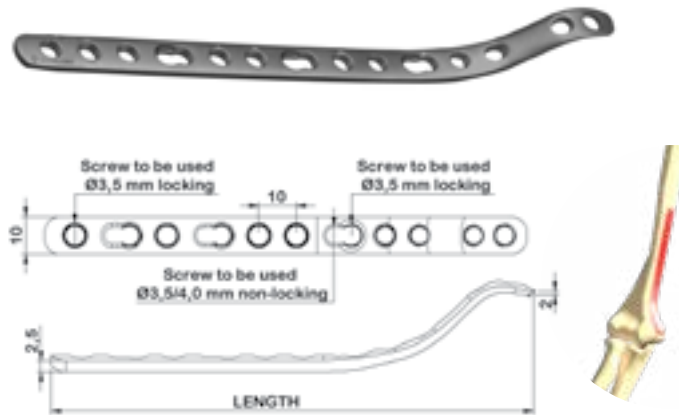

Screw to be used		Thickness (mm)	Width (mm)	
Ø (3,5 / 4,0 mm)		2,5	10	
SS	TI	HOLES	LENGTH (mm)	
O5249206	O5249106	6	69,5	
O5249208	O5249108	8	94	
O5249210	O5249110	10	114	
O5249212	O5249112	12	138,5	
O5249214	O5249114	14	163	
O5249216	O5249116	16	184	

2,7 / 3,5 mm Distal Medial Humerus Locking Plate 2

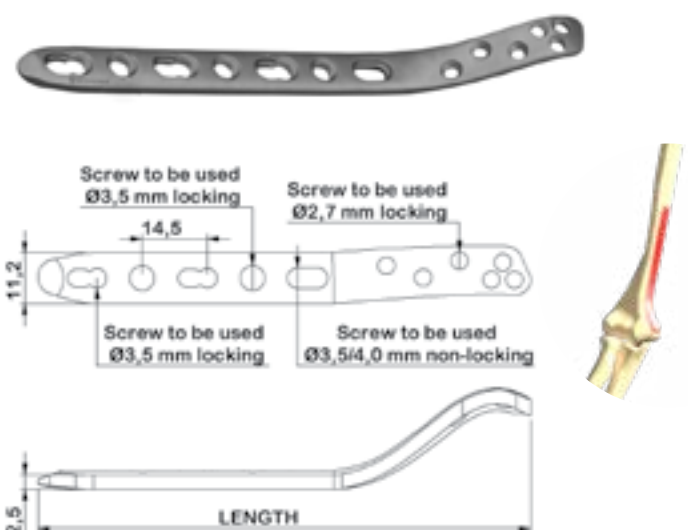

Screw to be used		Thickness (mm)	Width (mm)	
Ø (2,7 / 3,5 / 4,0 mm)		2,5	11,2	
SS	TI	HOLES	SIDE	LENGTH (mm)
O1015279106	O1115278106	6	Left	84,8
O1015279108	O1115278108	8	Left	109,3
O1015279110	O1115278110	10	Left	133,8
O1015279112	O1115278112	12	Left	158,3
O1015279114	O1115278114	14	Left	182,8
O1015279116	O1115278116	16	Left	207,3
O1015279206	O1115278206	6	Right	84,8
O1015279208	O1115278208	8	Right	109,3
O1015279210	O1115278210	10	Right	133,8
O1015279212	O1115278212	12	Right	158,3
O1015279214	O1115278214	14	Right	182,8
O1015279216	O1115278216	16	Right	207,3

## 3,5 mm Y - Distal Humerus Locking Plate 1

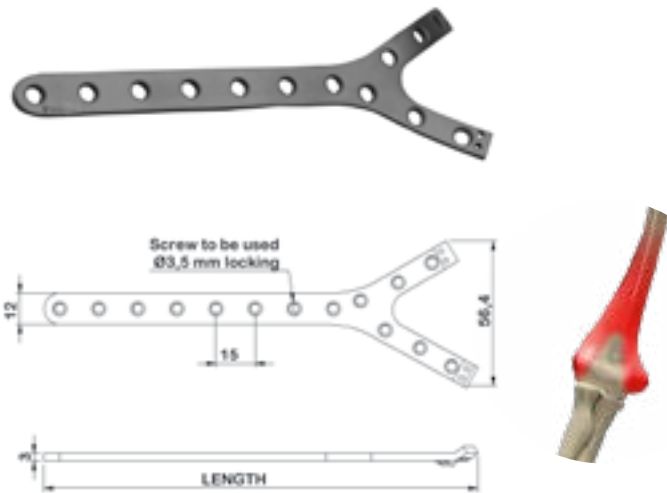

Screw to be used		Thickness (mm)	Width (mm)		
Ø (3,5 mm)		3	12 - 56,4		
SS	TI	HOLES	SIDE	LENGTH (mm)	
O5319103	O5318103	3	Left	91,4	
O5319104	O5318104	4	Left	106,4	
O5319105	O5318105	5	Left	121,4	
O5319106	O5318106	6	Left	136,4	
O5319107	O5318107	7	Left	151,4	
O5319108	O5318108	8	Left	166,4	
O5319203	O5318203	3	Right	91,4	
O5319204	O5318204	4	Right	106,4	
O5319205	O5318205	5	Right	121,4	
O5319206	O5318206	6	Right	136,4	
O5319207	O5318207	7	Right	151,4	
O5319208	O5318208	8	Right	166,4	

## 3,5 mm Olecranon Locking Compression Plate 1

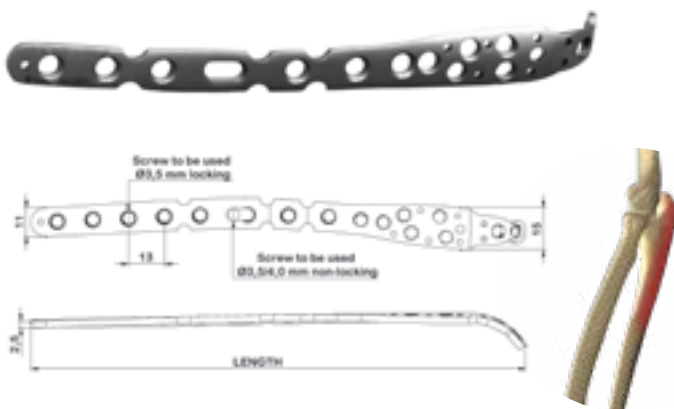

Screw to be used		Thickness (mm)	Width (mm)		
Ø (4,0/3,5/2,7/2,3 mm)		2,5	11,0 - 15,0		
SS	TI	HOLES	SIDE	LENGTH (mm)	
O1651904	O1651804	4	Left	128,8	
O1651906	O1651806	6	Left	153,7	
O1651908	O1651808	8	Left	179,8	
O1662904	O1662804	4	Right	128,8	
O1662906	O1662806	6	Right	153,7	
O1662908	O1662808	8	Right	179,8	

## 3,5 mm Olecranon Locking Compression Plate 2

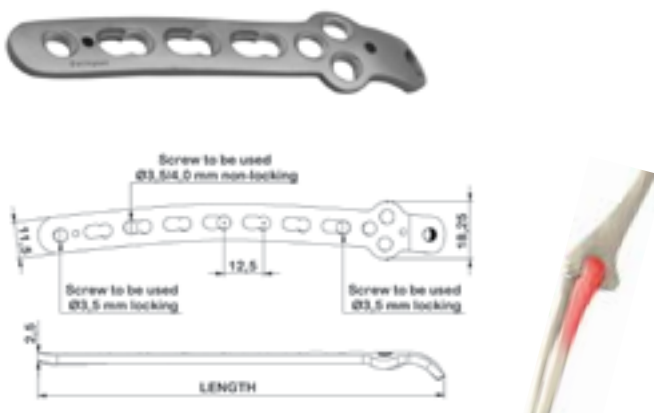

Screw to be used		Thickness (mm)	Width (mm)		
Ø (3,5 / 4,0 mm)		2,5	11,5 - 18,25		
SS	TI	HOLES	SIDE	LENGTH (mm)	
O22024130	O22014130	3	Left	67,2	
O22024140	O22014140	4	Left	79,6	
O22024150	O22014150	5	Left	92,1	
O22024160	O22014160	6	Left	104,6	
O22024170	O22014170	7	Left	117	
O22024180	O22014180	8	Left	129,4	
O22024230	O22014230	3	Right	67,2	
O22024240	O22014240	4	Right	79,6	
O22024250	O22014250	5	Right	92,1	
O22024260	O22014260	6	Right	104,6	
O22024270	O22014270	7	Right	117	
O22024280	O22014280	8	Right	129,4	

3,5 mm Metaphysis Locking Compression Plate

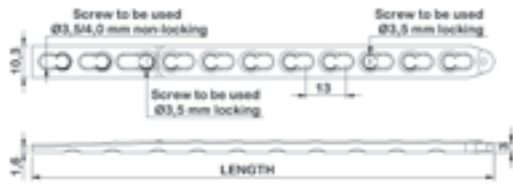

Screw to be used	Thickness (mm)	Width (mm)	
Ø (3,5 / 4,0 mm)	3	10,3	
SS	TI	HOLES	LENGTH (mm)
O1060906	O1060806	6	86
O1060907	O1060807	7	99
O1060908	O1060808	8	112
O1060909	O1060809	9	125
O1060911	O1060811	11	151
O1060913	O1060813	13	177

3,5 mm Locking Compression Hook Plate

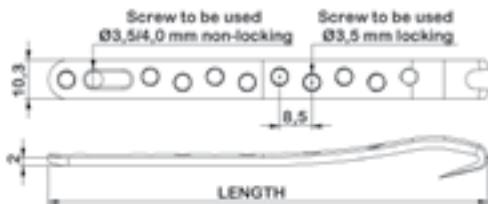

Screw to be used	Thickness (mm)	Width (mm)	
Ø (3,5 / 4,0 mm)	2,0	10,3	
SS	TI	HOLES	LENGTH (mm)
O1610905	O1610805	5	64,4
O1610906	O1610806	6	72,9
O1610907	O1610807	7	81,4
O1610908	O1610808	8	89,9
O1610909	O1610809	9	98,4
O1610910	O1610810	10	106,9
O1610911	O1610811	11	115,4
O1610912	O1610812	12	123,9
O1610913	O1610813	13	132,4

3,5 mm Locking Compression Plate

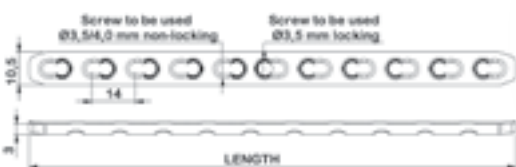

Screw to be used	Thickness (mm)	Width (mm)	
Ø (3,5 / 4,0 mm)	3	10,5	
SS	TI	HOLES	LENGTH (mm)
O1840904	O1820804	4	58
O1840905	O1820805	5	72
O1840906	O1820806	6	86
O1840907	O1820807	7	100
O1840908	O1820808	8	114
O1840909	O1820809	9	128
O1840910	O1820810	10	142
O1840911	O1820811	11	156
O1840912	O1820812	12	170

1/3 Tubular Locking Plate

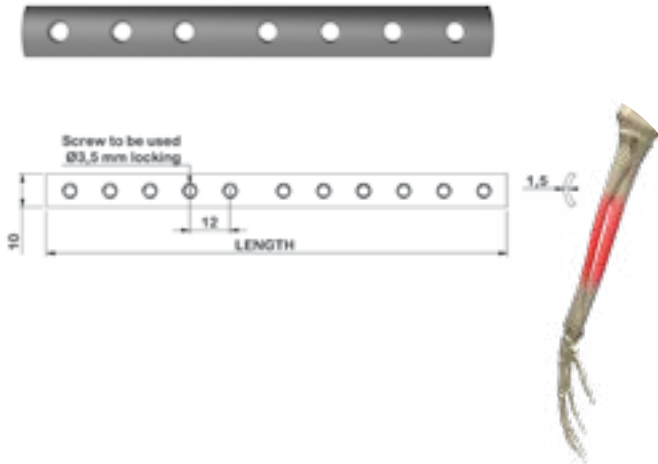

Screw to be used	Thickness (mm)	Width(mm)	
Ø (3,5 mm)	1,5	10,0	
SS	TI	HOLES	LENGTH (mm)
O5051004	O5050004	4	54
O5051005	O5050005	5	66
O5051006	O5050006	6	78
O5051007	O5050007	7	90
O5051008	O5050008	8	102
O5051009	O5050009	9	114
O5051010	O5050010	10	126
O5051011	O5050011	11	138
O5051012	O5050012	12	150
O5051013	O5050013	13	162

3,5 mm Reconstruction Locking Plate

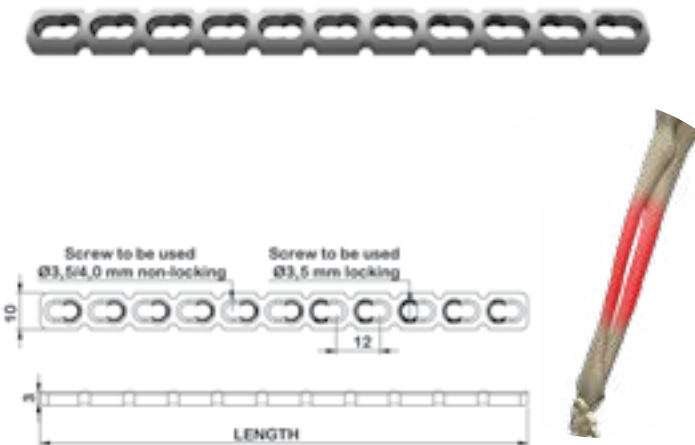

Screw to be used	Thickness (mm)	Width (mm)	
Ø (3,5 / 4,0 mm)	3	10,0	
SS	TI	HOLES	LENGTH (mm)
O1050904	O1050804	4	48
O1050905	O1050805	5	60
O1050906	O1050806	6	72
O1050907	O1050807	7	84
O1050908	O1050808	8	96
O1050909	O1050809	9	108
O1050910	O1050810	10	120
O1050911	O1050811	11	132
O1050912	O1050812	12	144

3,5 mm Ulna / Radius Anatomic Locking Plate

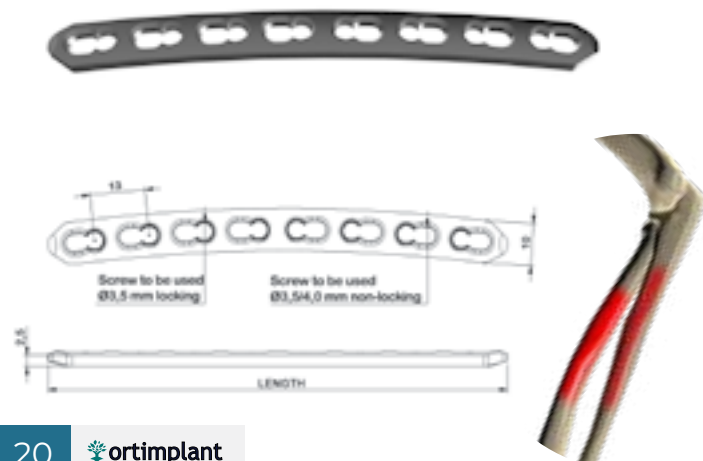

Screw to be used	Thickness (mm)	Width (mm)	
Ø (3,5/4,0 mm)	2,5	10,0	
SS	TI	HOLES	LENGTH (mm)
O1822005	O1821005	5	69
O1822006	O1821006	6	82
O1822007	O1821007	7	95,4
O1822008	O1821008	8	108,8
O1822009	O1821009	9	121,2

3,5 mm Curved Reconstruction Locking Plate

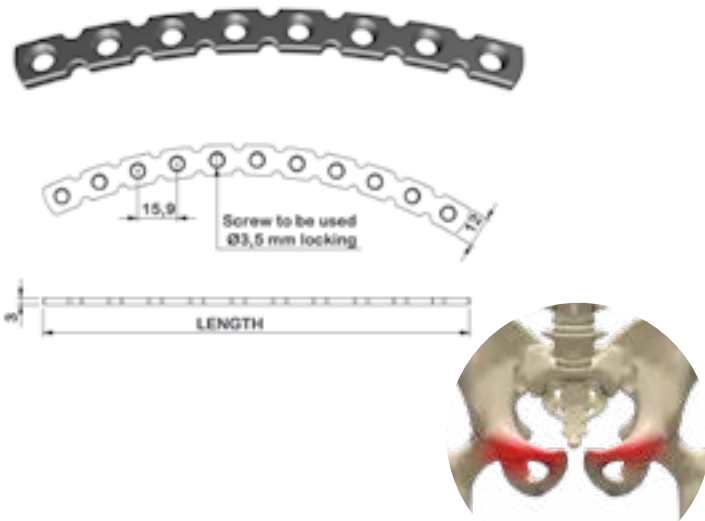

Screw to be used		Thickness (mm)	Width (mm)	
Ø (3,5 mm)		3,0	12,0	
SS	TI	HOLES	LENGTH (mm)	
O101 02 221 0004	O111 02 221 0004	4	61,4	
O101 02 221 0005	O111 02 221 0005	5	77,8	
O101 02 221 0006	O111 02 221 0006	6	93,7	
O101 02 221 0007	O111 02 221 0007	7	109,4	
O101 02 221 0008	O111 02 221 0008	8	125,0	
O101 02 221 0009	O111 02 221 0009	9	140,2	
O101 02 221 0010	O111 02 221 0010	10	155,0	
O101 02 221 0011	O111 02 221 0011	11	169,9	
O101 02 221 0012	O111 02 221 0012	12	184,7	
O101 02 221 0013	O111 02 221 0013	13	198,0	
O101 02 221 0014	O111 02 221 0014	14	212,0	

2,7 / 3,5 mm Distal Radius Locking Plate 1

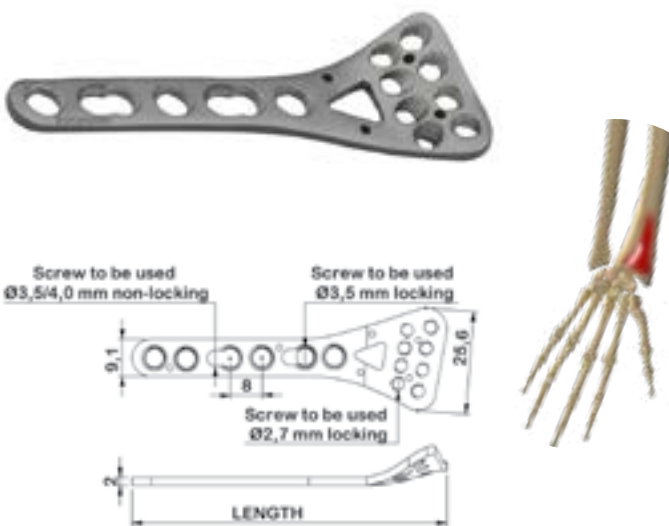

Screw to be used		Thickness (mm)	Width (mm)		
Ø (2,7/3,5/4,0 mm)		2,0	9,1 - 25,6		
SS	TI	HOLES	SIDE	LENGTH (mm)	
O5159303	O5159103	3	Left	54	
O5159304	O5159104	4	Left	62	
O5159305	O5159105	5	Left	70	
O5159306	O5159106	6	Left	78	
O5159307	O5159107	7	Left	86	
O5159403	O5159203	3	Right	54	
O5159404	O5159204	4	Right	62	
O5159405	O5159205	5	Right	70	
O5159406	O5159206	6	Right	78	
O5159407	O5159207	7	Right	86	

2,7 / 3,5 mm Distal Radius Locking Plate 2

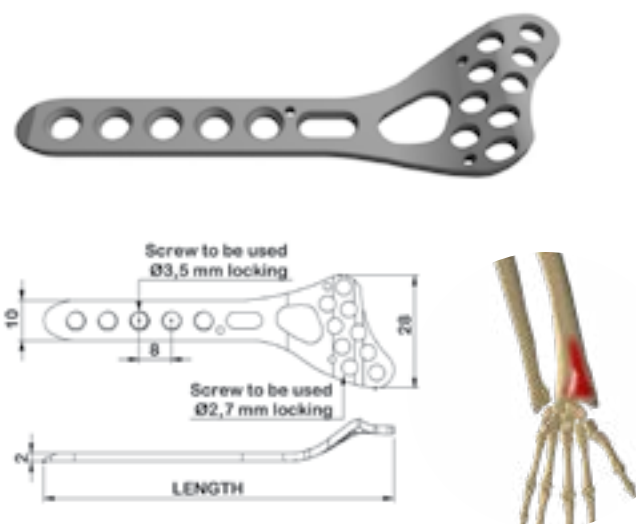

Screw to be used		Thickness (mm)	Width (mm)		
Ø (2,7/3,5 mm)		2,0	10,0 - 28,0		
SS	TI	HOLES	SIDE	LENGTH (mm)	
O5169303	O5169103	3	Left	63,2	
O5169304	O5169104	4	Left	71,2	
O5169305	O5169105	5	Left	79,2	
O5169306	O5169106	6	Left	87,2	
O5169307	O5169107	7	Left	95,2	
O5169403	O5169203	3	Right	63,2	
O5169404	O5169204	4	Right	71,2	
O5169405	O5169205	5	Right	79,2	
O5169406	O5169206	6	Right	87,2	
O5169407	O5169207	7	Right	95,2	

3,5 mm Locking Compression T - Plate Right - Angled (3 Holes on Head)

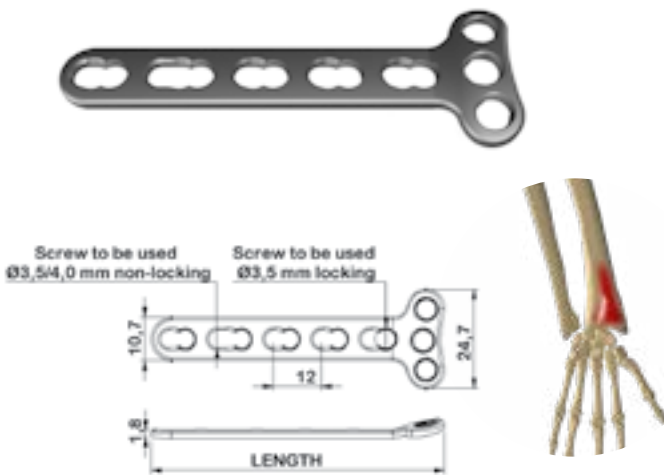

Screw to be used	Thickness (mm)	Width (mm)	
Ø (3,5 / 4,0mm)	1,8	10,7 - 24,7	
SS	TI	HOLES	LENGTH (mm)
O1480903	O1480803	3	49
O1480904	O1480804	4	61
O1480905	O1480805	5	73
O1480906	O1480806	6	85

3,5 mm Locking Compression T - Plate Oblique - Angled



Screw to be used	Thickness (mm)	Width (mm)		
Ø (3,5 / 4,0 mm)	2	10,0 - 23,8		
SS	TI	HOLES	SIDE	LENGTH (mm)
O1511903	O1511803	3	Left	53
O1511904	O1511804	4	Left	66,5
O1511905	O1511805	5	Left	80
O1511906	O1511806	6	Left	93,5
O1522903	O1522803	3	Right	53
O1522904	O1522804	4	Right	66,5
O1522905	O1522805	5	Right	80
O1522906	O1522806	6	Right	93,5

3,5 mm Locking Compression T - Plate Right - Angled (4 Holes on Head)

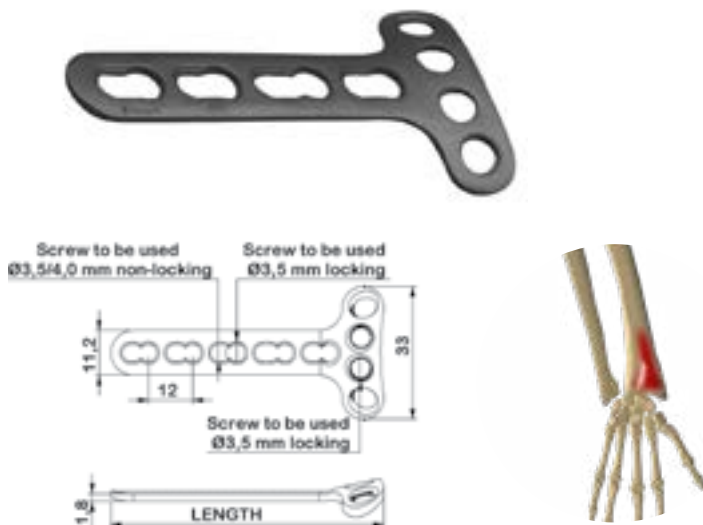

Screw to be used	Thickness (mm)	Width (mm)	
Ø (3,5 / 4,0 mm)	1,8	11,2 - 33,0	
SS	TI	HOLES	LENGTH (mm)
O1480930	O1480830	3	46
O1480940	O1480840	4	57
O1480950	O1480850	5	68
O1480960	O1480860	6	80

2,7 mm Radius Head Locking Plate

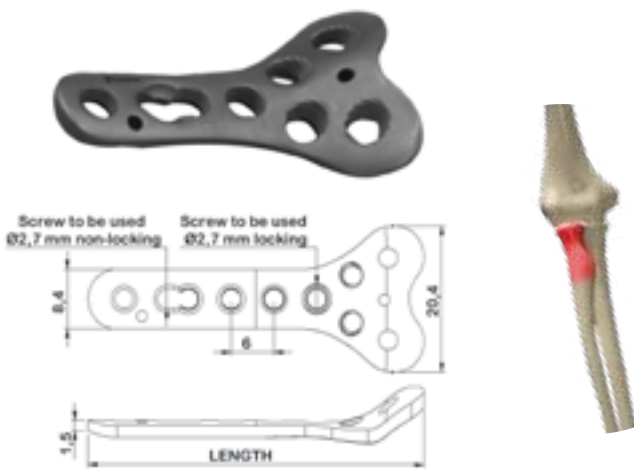

Screw to be used		Thickness (mm)	Width (mm)
Ø (2,7 mm)		1,5	8,4 - 20,4
SS	TI	HOLES	LENGTH (mm)
O5159603	O5159503	3	33
O5159605	O5159505	5	47

2,7 mm Hallux - Valgus Locking Plate

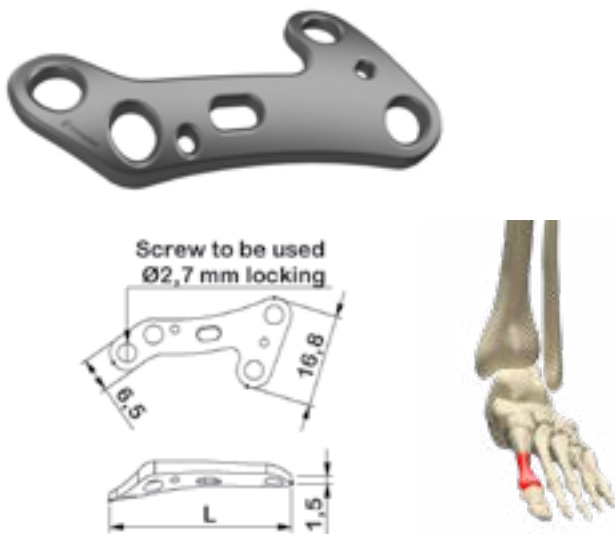

Screw to be used		Thickness (mm)	Width (mm)	
Ø (2,7 mm)		1,5	6,5 - 16,8	
TI	HOLES	SIDE	LENGTH (mm)	
O312 02 062 0402	2	90° Left	33	
O312 02 062 0403	3	90° Left	35	
O312 02 062 0404	4	90° Left	37	
O312 02 062 0202	2	110° Left	33	
O312 02 062 0203	3	110° Left	35	
O312 02 062 0204	4	110° Left	37	
O312 02 061 0302	2	90° Right	33	
O312 02 061 0303	3	90° Right	35	
O312 02 061 0304	4	90° Right	37	
O312 02 061 0102	2	110° Right	33	
O312 02 061 0103	3	110° Right	35	
O312 02 061 0104	4	110° Right	37	

Attachment Locking Plate

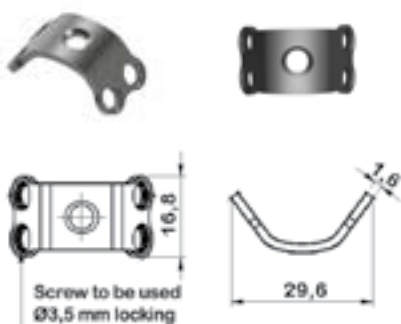

Screw to be used	Thickness (mm)
Ø (3,5 mm)	1,8
TI	TYPE
O110 02 190 0006	Small



# SMALL FRAGMENT LOCKING SCREWS

---

product  
group





## 3,5 mm Self - Tapping Locking Screw



SS	TI	DIA. x LENGTH (mm)	SS	TI	DIA. x LENGTH (mm)
O1993510	O1983510	3,5X10	O1993534	O1983534	3,5X34
O1993512	O1983512	3,5X12	O1993536	O1983536	3,5X36
O1993514	O1983514	3,5X14	O1993538	O1983538	3,5X38
O1993516	O1983516	3,5X16	O1993540	O1983540	3,5X40
O1993518	O1983518	3,5X18	O1993542	O1983542	3,5X42
O1993520	O1983520	3,5X20	O1993544	O1983544	3,5X44
O1993522	O1983522	3,5X22	O1993546	O1983546	3,5X46
O1993524	O1983524	3,5X24	O1993548	O1983548	3,5X48
O1993526	O1983526	3,5X26	O1993550	O1983550	3,5X50
O1993528	O1983528	3,5X28	O1993555	O1983555	3,5X55
O1993530	O1983530	3,5X30	O1993560	O1983560	3,5X60
O1993532	O1983532	3,5X32			

## 3,5 mm Low - Profile Locking Screw



TI	DIA. x LENGTH (mm)
O1973510	3,5X10
O1973512	3,5X12
O1973514	3,5X14
O1973516	3,5X16
O1973518	3,5X18
O1973520	3,5X20
O1973522	3,5X22
O1973524	3,5X24
O1973526	3,5X26
O1973528	3,5X28

## 3,5 mm Locking Cancellous Screw Full Threaded



SS	TI	DIA. x LENGTH (mm)	SS	TI	DIA. x LENGTH (mm)
O33803510	O33703510	3,5X10	O33803534	O33703534	3,5X34
O33803512	O33703512	3,5X12	O33803536	O33703536	3,5X36
O33803514	O33703514	3,5X14	O33803538	O33703538	3,5X38
O33803516	O33703516	3,5X16	O33803540	O33703540	3,5X40
O33803518	O33703518	3,5X18	O33803542	O33703542	3,5X42
O33803520	O33703520	3,5X20	O33803544	O33703544	3,5X44
O33803522	O33703522	3,5X22	O33803546	O33703546	3,5X46
O33803524	O33703524	3,5X24	O33803548	O33703548	3,5X48
O33803526	O33703526	3,5X26	O33803550	O33703550	3,5X50
O33803528	O33703528	3,5X28	O33803555	O33703555	3,5X55
O33803530	O33703530	3,5X30	O33803560	O33703560	3,5X60
O33803532	O33703532	3,5X32			

## 3,5 mm Locking Cancellous Screw Partially Threaded



SS	TI	DIA. x LENGTH (mm)	SS	TI	DIA. x LENGTH (mm)
O33813520	O33713520	3,5X20	O33813538	O33713538	3,5X38
O33813522	O33713522	3,5X22	O33813540	O33713540	3,5X40
O33813524	O33713524	3,5X24	O33813542	O33713542	3,5X42
O33813526	O33713526	3,5X26	O33813544	O33713544	3,5X44
O33813528	O33713528	3,5X28	O33813546	O33713546	3,5X46
O33813530	O33713530	3,5X30	O33813548	O33713548	3,5X48
O33813532	O33713532	3,5X32	O33813550	O33713550	3,5X50
O33813534	O33713534	3,5X34	O33813555	O33713555	3,5X55
O33813536	O33713536	3,5X36	O33813560	O33713560	3,5X60

## 3,5 mm Cable Locking Screw

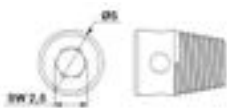

TI  
O900 03 020 0005

## 3,5 mm Locking Screw Plug



TI  
O900 03 020 0009

## 2,4 mm Locking Screw (5,5 mm Head DIA.)



SS	TI	DIA. x LENGTH (mm)	SS	TI	DIA. x LENGTH (mm)
O1992306	O2065014	2,4X6,0	O1992324	O2065032	2,4X24
O1992308	O2065016	2,4X8,0	O1992326	O2065034	2,4X26
O1992310	O2065018	2,4X10	O1992328	O2065036	2,4X28
O1992312	O2065020	2,4X12	O1992330	O2065038	2,4X30
O1992314	O2065022	2,4X14	O1992332	O2065040	2,4X32
O1992316	O2065024	2,4X16	O1992334	O2065042	2,4X34
O1992318	O2065026	2,4X18	O1992336	O2065044	2,4X36
O1992320	O2065028	2,4X20	O1992338	O2065046	2,4X38
O1992322	O2065030	2,4X22	O1992340	O2065048	2,4X40

## 2,7 mm Mini Locking Screw (5,5 mm Head DIA.)

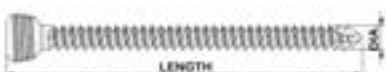

SS	TI	DIA. x LENGTH (mm)	SS	TI	DIA. x LENGTH (mm)
O1992706	O2065050	2,7X6,0	O1992724	O1992005	2,7X24
O1992708	O2065055	2,7X8,0	O1992726	O1992007	2,7X26
O1992710	O2065060	2,7X10	O1992728	O1992009	2,7X28
O1992712	O2065065	2,7X12	O1992730	O1992011	2,7X30
O1992714	O2065070	2,7X14	O1992732	O1992013	2,7X32
O1992716	O2065075	2,7X16	O1992734	O1992015	2,7X34
O1992718	O2065080	2,7X18	O1992736	O1992017	2,7X36
O1992720	O2065085	2,7X20	O1992738	O1992019	2,7X38
O1992722	O2065090	2,7X22	O1992740	O1992021	2,7X40

## 3,5 mm Self - Drilling Locking Screw



SS	TI	DIA. x LENGTH (mm)
O2393510	O2383510	3,5X10
O2393512	O2383512	3,5X12
O2393514	O2383514	3,5X14
O2393516	O2383516	3,5X16
O2393518	O2383518	3,5X18
O2393520	O2383520	3,5X20
O2393522	O2383522	3,5X22
O2393524	O2383524	3,5X24
O2393526	O2383526	3,5X26
O2393528	O2383528	3,5X28
O2393530	O2383530	3,5X30
O2393532	O2383532	3,5X32
O2393534	O2383534	3,5X34
O2393536	O2383536	3,5X36
O2393538	O2383538	3,5X38
O2393540	O2383540	3,5X40
O2393542	O2383542	3,5X42
O2393544	O2383544	3,5X44
O2393546	O2383546	3,5X46
O2393548	O2383548	3,5X48
O2393550	O2383550	3,5X50
O2393555	O2383555	3,5X55
O2393560	O2383560	3,5X60

## 3,5 mm Self - Tapping Locking Cannulated Screw



SS	TI	DIA. x LENGTH (mm)	SS	TI	DIA. x LENGTH (mm)
O1953510	O1963510	3,5X10	O1863534	O1963534	3,5X34
O1953512	O1963512	3,5X12	O1863536	O1963536	3,5X36
O1953514	O1963514	3,5X14	O1863538	O1963538	3,5X38
O1953516	O1963516	3,5X16	O1953540	O1963540	3,5X40
O1953518	O1963518	3,5X18	O1863518	O1963565	3,5X42
O1953520	O1963520	3,5X20	O1863520	O1963570	3,5X44
O1953522	O1963522	3,5X22	O1863522	O1963546	3,5X46
O1953524	O1963524	3,5X24	O1863524	O1963548	3,5X48
O1953526	O1963526	3,5X26	O1953550	O1963550	3,5X50
O1953528	O1963528	3,5X28	O1953555	O1963555	3,5X55
O1953530	O1963530	3,5X30	O1953560	O1963560	3,5X60
O1863532	O1963532	3,5X32			



# SMALL FRAGMENT NON LOCKING PLATES

---

product  
group



3,5 mm Clavicle Plate

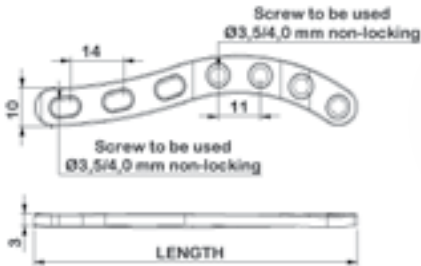

Screw to be used		Thickness (mm)	Width (mm)	
Ø (3,5 / 4,0 mm)		3,0	10,0	
SS	TI	HOLES	SIDE	LENGTH (mm)
O5089106	O5088106	6	Left	70
O5089107	O5088107	7	Left	84
O5089108	O5088108	8	Left	98
O5089109	O5088109	9	Left	112
O5089206	O5088206	6	Right	70
O5089207	O5088207	7	Right	84
O5089208	O5088208	8	Right	98
O5089209	O5088209	9	Right	112

3,5 mm Clavicle Hook Plate

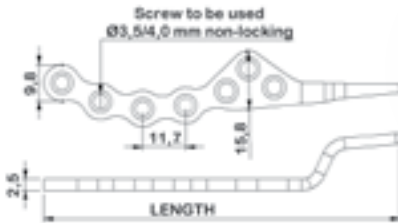

Screw to be used		Thickness (mm)	Width (mm)	
Ø (3,5 / 4,0 mm)		3,0	9,8 - 15,8	
SS	TI	HOLES	SIDE	LENGTH (mm)
O5269104	O5268104	4	Left	63
O5269105	O5268105	5	Left	75
O5269106	O5268106	6	Left	86
O5269107	O5268107	7	Left	97
O5269204	O5268204	4	Right	63
O5269205	O5268205	5	Right	75
O5269206	O5268206	6	Right	86
O5269207	O5268207	7	Right	97

3,5 mm Cloverleaf Plate

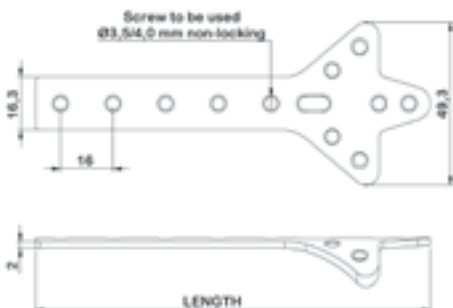

Screw to be used		Thickness (mm)	Width (mm)	
Ø (3,5 / 4,0 mm)		2,0	16,3 - 49,3	
SS	TI	HOLES	LENGTH (mm)	
O100 02 270 0003	O110 02 270 0003	3	88,1	
O100 02 270 0004	O110 02 270 0004	4	104,1	
O100 02 270 0005	O110 02 270 0005	5	120,1	
O100 02 270 0006	O110 02 270 0006	6	136,1	
O100 02 270 0007	O110 02 270 0007	7	152,1	
O100 02 270 0008	O110 02 270 0008	8	168,1	

## 3,5 mm Y - Distal Humerus Plate 1

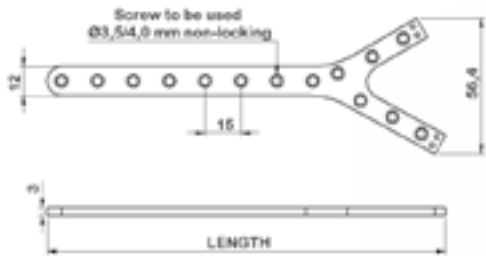

Screw to be used		Thickness (mm)	Width (mm)		
Ø (3,5 / 4,0 mm)		3,0	12,0 - 56,4		
SS	TI	HOLES	SIDE	LENGTH (mm)	
O5219103	O5218103	3	Left	91,4	
O5219104	O5218104	4	Left	106,4	
O5219105	O5218105	5	Left	121,4	
O5219106	O5218106	6	Left	136,4	
O5219107	O5218107	7	Left	151,4	
O5219108	O5218108	8	Left	166,4	
O5219203	O5218203	3	Right	91,4	
O5219204	O5218204	4	Right	106,4	
O5219205	O5218205	5	Right	121,4	
O5219206	O5218206	6	Right	136,4	
O5219207	O5218207	7	Right	151,4	
O5219208	O5218208	8	Right	166,4	

## 3,5 mm Y - Distal Humerus Plate 2

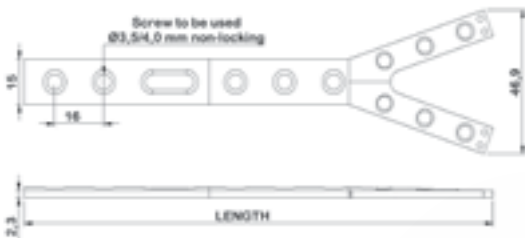

Screw to be used		Thickness (mm)	Width (mm)		
Ø (3,5 / 4,0 mm)		2,3	15,0 - 46,9		
SS	TI	HOLES	SIDE	LENGTH (mm)	
O100 02 224 1305	O110 02 224 1305	5	Left	137	
O100 02 224 1306	O110 02 224 1306	6	Left	153	
O100 02 224 1307	O110 02 224 1307	7	Left	169	
O100 02 224 1309	O110 02 224 1309	9	Left	201	
O100 02 224 1205	O110 02 224 1205	5	Right	137	
O100 02 224 1206	O110 02 224 1206	6	Right	153	
O100 02 224 1207	O110 02 224 1207	7	Right	169	
O100 02 224 1209	O110 02 224 1209	9	Right	201	

3,5 mm Ulnar Olecranon Plate

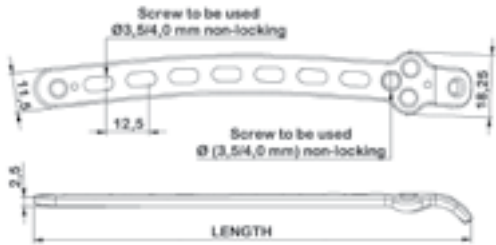

Screw to be used	Thickness (mm)		Width (mm)	
Ø (3,5 / 4,0 mm)	2,5		11,5 - 18,25	
SS	TI	HOLES	SIDE	LENGTH (mm)
O100 02 224 1104	O22014040	4	Left	79,6
O100 02 224 1105	O22014050	5	Left	92,1
O100 02 224 1103	O22014060	6	Left	104,6
O100 02 224 1004	O22014030	4	Right	79,6
O100 02 224 1005	O22014070	5	Right	92,1
O100 02 224 1003	O22014080	6	Right	104,6

3,5 mm Distal Medial Humerus Reconstruction Plate

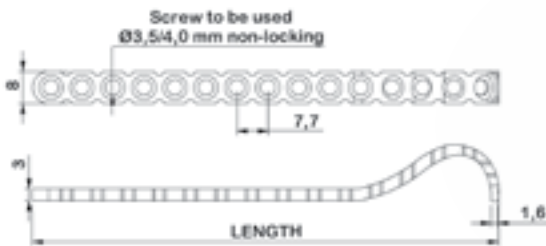

Screw to be used	Thickness (mm)		Width (mm)	
Ø (3,5 / 4,0 mm)	3,0		8,0	
TI	HOLES		LENGTH (mm)	
O5249010	10		69,6	
O5249012	12		85	
O5249014	14		100,4	

3,5 mm Y - Distal Humerus Reconstruction Plate

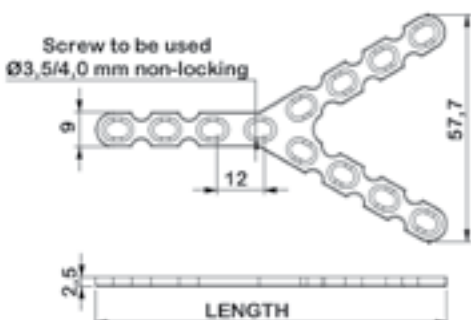

Screw to be used	Thickness (mm)		Width (mm)	
Ø (3,5 / 4,0 mm)	2,5		9,0 - 57,7	
SS	TI	LENGTH (mm)		
O100 02 224 0000	O110 02 224 0000	88,6		

## 1/3 Tubular Plate

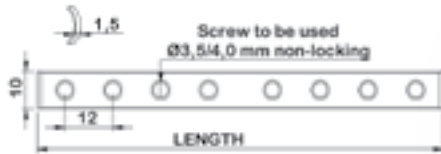

Screw to be used	Thickness (mm)	Width (mm)	
Ø (3,5 / 4,0 mm)	1,5	10,0	
SS	TI	HOLES	LENGTH (mm)
O100 02 181 0004	O110 02 181 0004	4	54
O100 02 181 0005	O110 02 181 0005	5	66
O100 02 181 0006	O110 02 181 0006	6	78
O100 02 181 0007	O110 02 181 0007	7	90
O100 02 181 0008	O110 02 181 0008	8	102
O100 02 181 0009	O110 02 181 0009	9	114
O100 02 181 0010	O110 02 181 0010	10	126
O100 02 181 0011	O110 02 181 0011	11	138
O100 02 181 0012	O110 02 181 0012	12	150

## Quarter 1/4 Tubular Plate

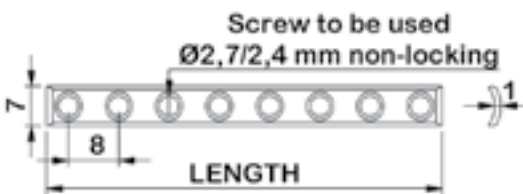

Screw to be used	Thickness (mm)	Width (mm)	
Ø (2,4 / 2,7mm)	1,0	7,0	
SS	TI	HOLES	LENGTH (mm)
O100 02 182 0003	O110 02 170 0003	3	23
O100 02 182 0004	O110 02 170 0004	4	31
O100 02 182 0005	O110 02 170 0005	5	39
O100 02 182 0006	O110 02 170 0006	6	47
O100 02 182 0007	O110 02 170 0007	7	55
O100 02 182 0008	O110 02 170 0008	8	63
O100 02 182 0009	O110 02 170 0009	9	71
O100 02 182 0010	O110 02 170 0010	10	79

## 3,5 mm Thin Narrow Plate DCP

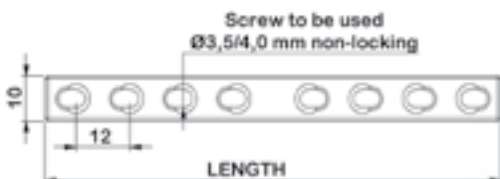

Screw to be used	Thickness (mm)	Width (mm)	
Ø (3,5 / 4,0 mm)	2,5	10,0	
SS	TI	HOLES	LENGTH (mm)
O100 02 171 0004	O110 02 171 0004	4	54
O100 02 171 0005	O110 02 171 0005	5	66
O100 02 171 0006	O110 02 171 0006	6	78
O100 02 171 0007	O110 02 171 0007	7	90
O100 02 171 0008	O110 02 171 0008	8	102
O100 02 171 0009	O110 02 171 0009	9	114
O100 02 171 0010	O110 02 171 0010	10	126
O100 02 171 0012	O110 02 171 0012	12	150



3,5 mm Straight Reconstruction Plate

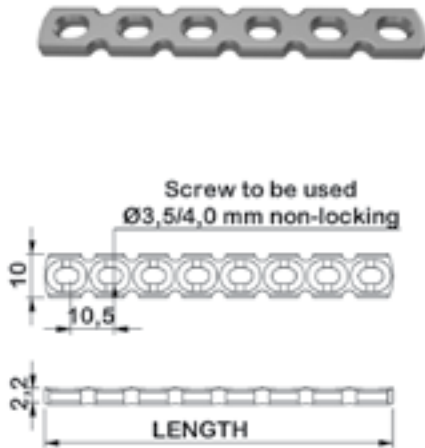

Screw to be used	Thickness (mm)	Width (mm)	
Ø (3,5 / 4,0 mm)	2,2	10,0	
SS	TI	HOLES	LENGTH (mm)
O100 02 220 0004	O110 02 220 0004	4	48
O100 02 220 0005	O110 02 220 0005	5	60
O100 02 220 0006	O110 02 220 0006	6	72
O100 02 220 0007	O110 02 220 0007	7	84
O100 02 220 0008	O110 02 220 0008	8	96
O100 02 220 0009	O110 02 220 0009	9	108
O100 02 220 0010	O110 02 220 0010	10	120
O100 02 220 0011	O110 02 220 0011	11	132
O100 02 220 0012	O110 02 220 0012	12	144

3,5 mm Curved Reconstruction Plate

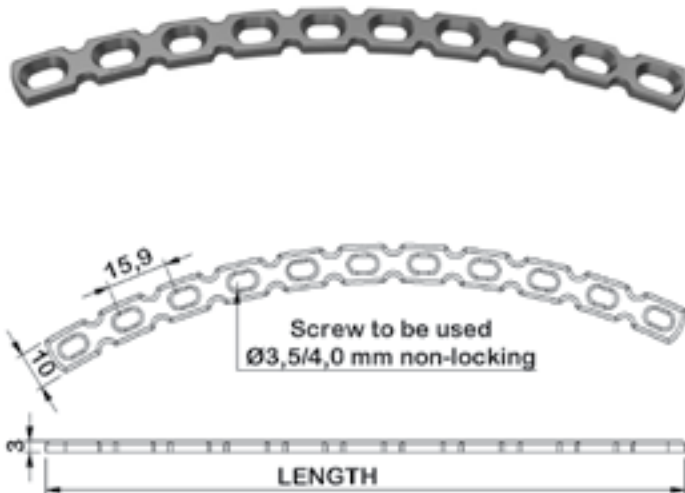

Screw to be used	Thickness (mm)	Width (mm)	
Ø (3,5 / 4,0 mm)	3,0	10,0	
SS	TI	HOLES	LENGTH (mm)
O100 02 221 0002	O110 02 221 0002	2	29,1
O100 02 221 0003	O110 02 221 0003	3	45,1
O100 02 221 0004	O110 02 221 0004	4	60,8
O100 02 221 0005	O110 02 221 0005	5	76,9
O100 02 221 0006	O110 02 221 0006	6	92,7
O100 02 221 0007	O110 02 221 0007	7	108,2
O100 02 221 0008	O110 02 221 0008	8	123,6
O100 02 221 0009	O110 02 221 0009	9	138,7
O100 02 221 0010	O110 02 221 0010	10	153,9
O100 02 221 0011	O110 02 221 0011	11	168,4
O100 02 221 0012	O110 02 221 0012	12	183,2

3,5 mm T - Plate Right - Angled (3 Holes On Head)

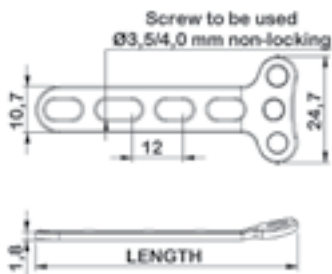

Screw to be used	Thickness (mm)	Width (mm)	
Ø (3,5 / 4,0mm)	1,8	10,7 - 24,7	
SS	TI	HOLES	LENGTH (mm)
O300 02 079 003	O310 02 079 003	3	49
O300 02 079 004	O310 02 079 004	4	61
O300 02 079 005	O310 02 079 005	5	73
O300 02 079 006	O310 02 079 006	6	85

3,5 mm T - Plate Right - Angled (4 Holes On Head)

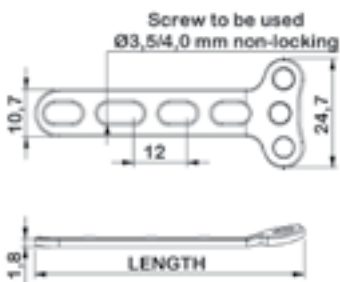

Screw to be used	Thickness (mm)	Width (mm)	
Ø (3,5 / 4,0mm)	1,8	10,7 - 33,0	
SS	TI	HOLES	LENGTH (mm)
O300 02 080 0003	O310 02 080 0003	3	46
O300 02 080 0004	O310 02 080 0004	4	57
O300 02 080 0005	O310 02 080 0005	5	68
O300 02 080 0006	O310 02 080 0006	6	79

3,5 mm Compression T - Plate Oblique - Angled

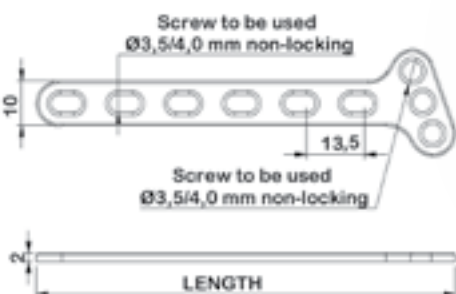

Screw to be used	Thickness (mm)	Width (mm)		
Ø (3,5 / 4,0 mm)	2,0	10,0		
SS	TI	HOLES	SIDE	LENGTH (mm)
O300 02 090 0003	O310 02 090 0003	3	Left	52,5
O300 02 090 0004	O310 02 090 0004	4	Left	66
O300 02 090 0005	O310 02 090 0005	5	Left	79,5
O300 02 090 0006	O310 02 090 0006	6	Left	93
O300 02 091 0003	O310 02 091 0003	3	Right	52,5
O300 02 091 0004	O310 02 091 0004	4	Right	66
O300 02 091 0005	O310 02 091 0005	5	Right	79,5
O300 02 091 0006	O310 02 091 0006	6	Right	93



# SMALL FRAGMENT NON LOCKING SCREWS

---

product  
group



## 3,5 mm Cortical Screw (Pitch 1,25 mm)



SS	TI	DIA. X LENGTH (mm)	SS	TI	DIA. X LENGTH (mm)
O100 03 218 0100	O110 03 218 0100	3,5X10	O100 03 218 0360	O110 03 218 0360	3,5X36
O100 03 218 0120	O110 03 218 0120	3,5X12	O100 03 218 0380	O110 03 218 0380	3,5X38
O100 03 218 0140	O110 03 218 0140	3,5X14	O100 03 218 0400	O110 03 218 0400	3,5X40
O100 03 218 0160	O110 03 218 0160	3,5X16	O100 03 218 0420	O110 03 218 0420	3,5X42
O100 03 218 0180	O110 03 218 0180	3,5X18	O100 03 218 0440	O110 03 218 0440	3,5X44
O100 03 218 0200	O110 03 218 0200	3,5X20	O100 03 218 0460	O110 03 218 0460	3,5X46
O100 03 218 0220	O110 03 218 0220	3,5X22	O100 03 218 0480	O110 03 218 0480	3,5X48
O100 03 218 0240	O110 03 218 0240	3,5X24	O100 03 218 0500	O110 03 218 0500	3,5X50
O100 03 218 0260	O110 03 218 0260	3,5X26	O100 03 218 0520	O110 03 218 0520	3,5X52
O100 03 218 0280	O110 03 218 0280	3,5X28	O100 03 218 0540	O110 03 218 0540	3,5X54
O100 03 218 0300	O110 03 218 0300	3,5X30	O100 03 218 0560	O110 03 218 0560	3,5X56
O100 03 218 0320	O110 03 218 0320	3,5X32	O100 03 218 0580	O110 03 218 0580	3,5X58
O100 03 218 0340	O110 03 218 0340	3,5X34	O100 03 218 0600	O110 03 218 0600	3,5X60

## 3,5 mm Cancellous Bone Screw Full Threaded



SS	TI	DIA. x LENGTH (mm)	SS	TI	DIA. x LENGTH (mm)
O100 03 219 0100	O110 03 219 0100	3,5X10	O100 03 219 0360	O110 03 219 0360	3,5X36
O100 03 219 0120	O110 03 219 0120	3,5X12	O100 03 219 0380	O110 03 219 0380	3,5X38
O100 03 219 0140	O110 03 219 0140	3,5X14	O100 03 219 0400	O110 03 219 0400	3,5X40
O100 03 219 0160	O110 03 219 0160	3,5X16	O100 03 219 0420	O6183542	3,5X42
O100 03 219 0180	O110 03 219 0180	3,5X18	O100 03 219 0440	O110 03 219 0450	3,5X44
O100 03 219 0200	O110 03 219 0200	3,5X20	O100 03 219 0460	O6183546	3,5X46
O100 03 219 0220	O110 03 219 0220	3,5X22	O100 03 219 0480	O6183548	3,5X48
O100 03 219 0240	O110 03 219 0240	3,5X24	O100 03 219 0500	O110 03 219 0500	3,5X50
O100 03 219 0260	O110 03 219 0260	3,5X26	O100 03 219 0520	O6183552	3,5X52
O100 03 219 0280	O110 03 219 0280	3,5X28	O100 03 219 0540	O110 03 219 0540	3,5X54
O100 03 219 0300	O110 03 219 0300	3,5X30	O100 03 219 0560	O6183556	3,5X56
O100 03 219 0320	O110 03 219 0320	3,5X32	O100 03 219 0580	O110 03 219 0580	3,5X58
O100 03 219 0340	O110 03 219 0340	3,5X34	O100 03 219 0600	O6183560	3,5X60

## 3,5 mm Cancellous Bone Screw Partially Threaded



SS	TI	DIA. x LENGTH (mm)
O6353520	O6153520	3,5X20
O6353522	O6153522	3,5X22
O6353524	O6153524	3,5X24
O6353526	O6153526	3,5X26
O6353528	O6153528	3,5X28
O6353530	O6153530	3,5X30
O6353532	O6153532	3,5X32
O6353534	O6153534	3,5X34
O6353536	O6153536	3,5X36
O6353538	O6153538	3,5X38
O6353540	O6153540	3,5X40
O6353542	O6153542	3,5X42
O6353544	O6153544	3,5X44
O6353546	O6153546	3,5X46
O6353548	O6153548	3,5X48
O6353550	O6153550	3,5X50

## 4,0 mm Cancellous Bone Screw Full Threaded

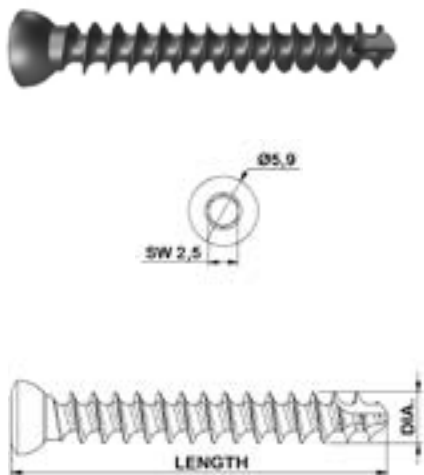

SS	TI	DIA. x LENGTH (mm)
O100 03 220 0100	O110 03 220 0100	4,0X10
O100 03 220 0120	O110 03 220 0120	4,0X12
O100 03 220 0140	O110 03 220 0140	4,0X14
O100 03 220 0160	O100 03 220 0160	4,0X16
O100 03 220 0180	O110 03 220 0180	4,0X18
O100 03 220 0200	O110 03 220 0200	4,0X20
O100 03 220 0220	O110 03 220 0220	4,0X22
O100 03 220 0240	O110 03 220 0240	4,0X24
O100 03 220 0260	O110 03 220 0260	4,0X26
O100 03 220 0280	O110 03 220 0280	4,0X28
O100 03 220 0300	O110 03 220 0300	4,0X30
O100 03 220 0350	O110 03 220 0350	4,0X35
O100 03 220 0400	O110 03 220 0380	4,0X38
O100 03 220 0450	O110 03 220 0450	4,0X45
O100 03 220 0500	O110 03 220 0500	4,0X50
O100 03 220 0550	O110 03 220 0550	4,0X55
O100 03 220 0600	O110 03 220 0600	4,0X60

## 4,0 mm Cancellous Bone Screw Partially Threaded



SS	TI	DIA. x LENGTH (mm)
O100 03 021 0200	O110 03 021 0200	4,0X20
O100 03 021 0220	O110 03 021 0220	4,0X22
O100 03 021 0240	O110 03 021 0240	4,0X24
O100 03 021 0260	O110 03 021 0260	4,0X26
O100 03 021 0280	O110 03 021 0280	4,0X28
O100 03 021 0300	O110 03 021 0300	4,0X30
O100 03 021 0350	O110 03 021 0350	4,0X35
O100 03 021 0400	O110 03 021 0400	4,0X40
O100 03 021 0450	O110 03 021 0450	4,0X45
O100 03 021 0500	O110 03 021 0500	4,0X50
O100 03 021 0550	O110 03 021 0550	4,0X55
O100 03 021 0600	O110 03 021 0600	4,0X60

## 2,7 mm Cortical Screw

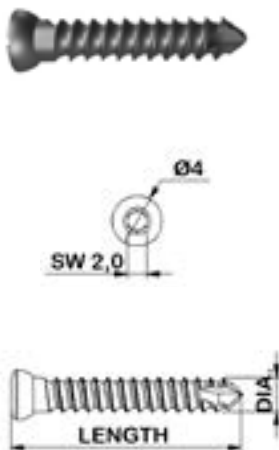

SS	TI	DIA. x LENGTH (mm)
O100 03 217 0060	O110 03 222 0110	2,7X6,0
O100 03 217 0080	O110 03 222 0112	2,7X8,0
O100 03 217 0100	O110 03 222 0140	2,7X10
O100 03 217 0120	O110 03 222 0160	2,7X12
O100 03 217 0140	O110 03 222 0180	2,7X14
O100 03 217 0160	O110 03 222 0200	2,7X16
O100 03 217 0180	O110 03 222 0220	2,7X18
O100 03 217 0200	O110 03 222 0240	2,7X20
O100 03 217 0220	O110 03 222 0260	2,7X22
O100 03 217 0240	O110 03 222 0280	2,7X24
O100 03 217 0260	O110 03 222 0300	2,7X26
O100 03 217 0280	O110 03 222 0320	2,7X28
O100 03 217 0300	O110 03 222 0340	2,7X30
O100 03 217 0320	O110 03 222 0360	2,7X32
O100 03 217 0340	O110 03 222 0380	2,7X34
O100 03 217 0360	O110 03 222 0400	2,7X36
O100 03 217 0380	O110 03 222 0420	2,7X38
O100 03 217 0400	O110 03 222 0440	2,7X40

## 2,4 mm Cortical Screw

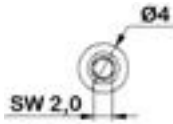

SS	TI	DIA. x LENGTH (mm)
O100 03 213 0060	O110 03 222 0460	2,4X6,0
O100 03 213 0080	O110 03 222 0480	2,4X8,0
O100 03 213 0100	O110 03 222 0500	2,4X10
O100 03 213 0120	O110 03 222 0520	2,4X12
O100 03 213 0140	O110 03 222 0540	2,4X14
O100 03 213 0160	O110 03 222 0560	2,4X16
O100 03 213 0180	O110 03 222 0580	2,4X18
O100 03 213 0200	O110 03 222 0600	2,4X20
O100 03 213 0220	O110 03 222 0620	2,4X22
O100 03 213 0240	O110 03 222 0640	2,4X24
O100 03 213 0260	O110 03 222 0650	2,4X26
O100 03 213 0280	O110 03 222 0700	2,4X28
O100 03 213 0300	O110 03 223 0100	2,4X30

## 2,0 mm Cortical Screw



SS	DIA. x LENGTH (mm)	SS	DIA. x LENGTH (mm)
O100 03 216 0060	2,0X6,0	O100 03 216 0220	2,0X22
O100 03 216 0080	2,0X8,0	O100 03 216 0240	2,0X24
O100 03 216 0100	2,0X10	O100 03 216 0260	2,0X26
O100 03 216 0120	2,0X12	O100 03 216 0280	2,0X28
O100 03 216 0140	2,0X14	O100 03 216 0300	2,0X30
O100 03 216 0160	2,0X16	O100 03 216 0320	2,0X32
O100 03 216 0180	2,0X18	O100 03 216 0340	2,0X34
O100 03 216 0200	2,0X20	O100 03 216 0360	2,0X36
		O100 03 216 0380	2,0X38

## 1,5 mm Cortical Screw

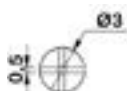

SS	DIA. x LENGTH (mm)	SS	DIA. x LENGTH (mm)
O100 03 215 0060	1,5X6	O100 03 215 0120	1,5X12
O100 03 215 0070	1,5X7	O100 03 215 0140	1,5X14
O100 03 215 0080	1,5X8	O100 03 215 0160	1,5X16
O100 03 215 0090	1,5X9	O100 03 215 0180	1,5X18
O100 03 215 0100	1,5X10	O100 03 215 0200	1,5X20



# MINI FRAGMENT LOCKING PLATES & SCREWS

---

product  
group





1,5 mm Mini Straight Compression Locking Plate

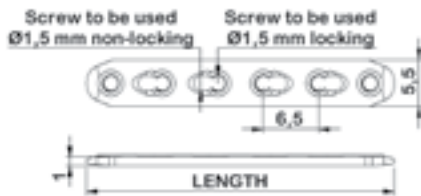

Screw to be used		
Ø (1,5 mm)		
TI	HOLES	LENGTH (mm)
O310 02 053 2704	4	23
O310 02 053 2706	6	36



1,5 mm Mini Straight Reconstruction Locking Plate

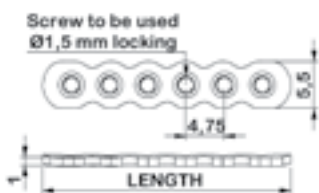

TI	HOLES	LENGTH (mm)
O310 02 053 2705	6	29
O310 02 053 2712	12	59



1,5 mm Mini T Locking Plate

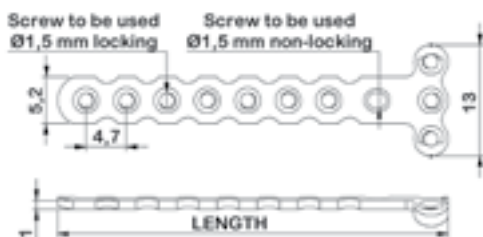

TI	SHAFT HOLES	HEAD HOLES	LENGTH (mm)
O310 02 053 2709	8	3	44,5
O310 02 053 2710	8	4	44,5



1,5 mm Mini Strut Locking Plate

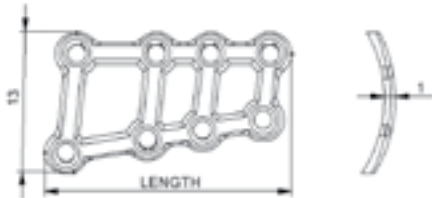

TI	SIDE	LENGTH (mm)
O310 02 053 2707	RIGHT	23
O310 02 053 2708	LEFT	23



1,5 mm Mini Y Locking Plate (3 holes head)

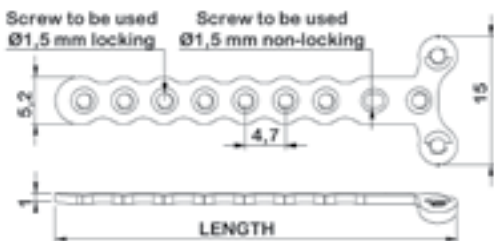

TI	SHAFT HOLES	HEAD HOLES	LENGTH (mm)
O310 02 053 2711	8	3	47



1,5 mm Mini Condylar Locking Plate

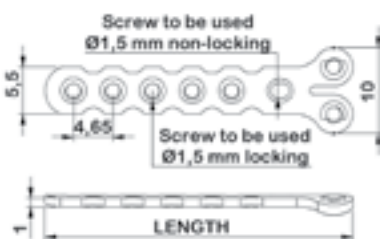

TI	SHAFT HOLES	HEAD HOLES	LENGTH (mm)
O310 02 053 0206	6	2	36



1,5 mm Mini Locking Screw



TI	DIA. x LENGTH (mm)
O1982606	1,5X6,0
O1982626	1,5X7,0
O1982608	1,5X8,0
O1982628	1,5X9,0
O1982610	1,5X10
O1982630	1,5X11
O1982612	1,5X12
O1982632	1,5X13
O1982614	1,5X14
O1982634	1,5X15
O1982616	1,5X16
O1982618	1,5X18
O1982620	1,5X20
O1982622	1,5X22
O1982624	1,5X24

1,5 mm Mini Screw



TI	DIA. x LENGTH (mm)
O110 03 215 0060	1,5X6,0
O110 03 215 0070	1,5X7,0
O110 03 215 0080	1,5X8,0
O110 03 215 0090	1,5X9,0
O110 03 215 0100	1,5X10
O110 03 215 0120	1,5X12
O110 03 215 0140	1,5X14
O110 03 215 0160	1,5X16
O110 03 215 0180	1,5X18
O110 03 215 0200	1,5X20

2,0 mm Mini Straight Locking Plate

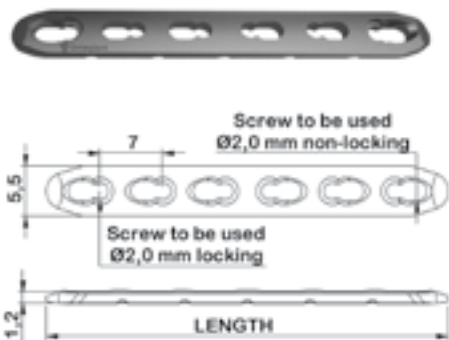

Screw to be used		
Ø (2,0 mm)		
TI	HOLES	LENGTH (mm)
O110 02 182 0004	4	31
O110 02 182 0005	5	38
O110 02 182 0006	6	45
O110 02 182 0007	7	52
O110 02 182 0008	8	59
O110 02 182 0010	10	73

\* DIA. Means DIAMETER

## 2,0 mm Mini Condylar Locking Plate ( 2 holes head )

TI	SHAFT HOLES	HEAD HOLES	LENGTH (mm)
O310 02 042 0003	7	2	54

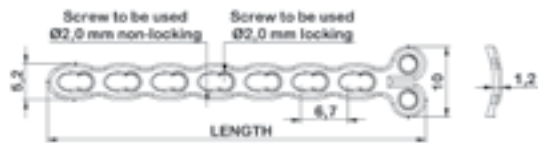

## 2,0 mm Mini Rotation Correction Locking Plate ( 2 holes head )

TI	SHAFT HOLES	HEAD HOLES	LENGTH (mm)
O310 02 051 0012	4	2	34
O310 02 051 0013	5	2	40

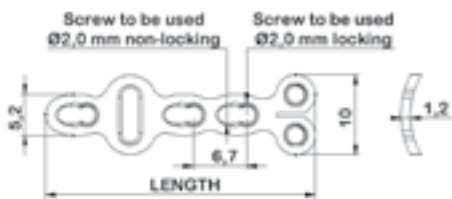

## 2,0 mm Mini T Locking Plate ( 3 holes head )

TI	SHAFT HOLES	HEAD HOLES	LENGTH (mm)
O310 02 042 0012	7	3	52,5



2,0 mm Mini Adaptation Locking Plate



TI	HOLES	LENGTH (mm)
O310 02 063 0003	12	81,26

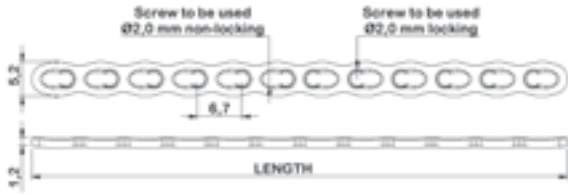

2,0 mm Mini Adaptation T Locking Plate (2 holes head)



TI	SHAFT HOLES	HEAD HOLES	LENGTH (mm)
O310 02 041 0103	7	2	52,5

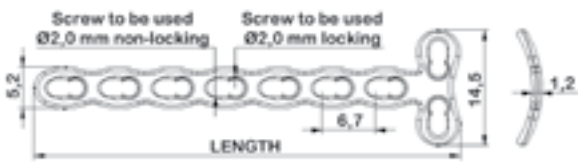

2,0 mm Mini Adaptation Y Locking Plate (3 holes head)



TI	SHAFT HOLES	HEAD HOLES	LENGTH (mm)
O110 02 182 0009	7	3	54

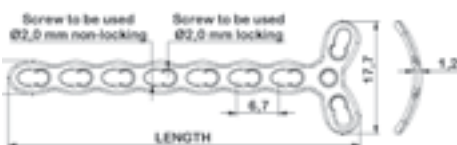

2,0 mm Mini H Locking Plate

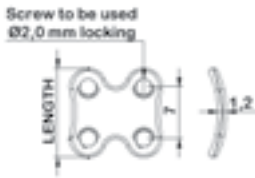

TI	HOLES	LENGTH
O110 02 182 0003	4	12



2,0 mm Mini Locking Screw

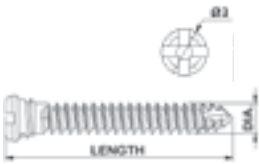

TI	DIA. x LENGTH (mm)
O1982005	2.0X6,0
O1982007	2.0X7,0
O1982017	2.0X8,0
O1982009	2.0X9,0
O1982019	2.0X10
O1982011	2.0X11
O1982021	2.0X12
O1982013	2.0X13
O1982023	2.0X14
O1982015	2.0X15
O1982025	2.0X16
O1982027	2.0X18
O1982636	2.0X20
O1982638	2.0X22
O1982640	2.0X24
O1983565	2.0X26
O1983570	2.0X28

2,0 mm Mini Screw

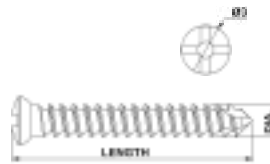

TI	DIA. x LENGTH (mm)
O110 03 216 0060	2.0X6,0
O110 03 216 0320	2.0X7,0
O110 03 216 0080	2.0X8,0
O110 03 216 0340	2.0X9,0
O110 03 216 0100	2.0X10
O110 03 216 0360	2.0X11
O110 03 216 0120	2.0X12
O110 03 216 0380	2.0X13
O110 03 216 0140	2.0X14
O110 03 216 0160	2.0X16
O110 03 216 0180	2.0X18
O110 03 216 0200	2.0X20
O110 03 216 0220	2.0X22
O110 03 216 0240	2.0X24
O110 03 216 0260	2.0X26
O110 03 216 0280	2.0X28
O110 03 216 0300	2.0X30

2,4 mm Mini Straight Locking Plate

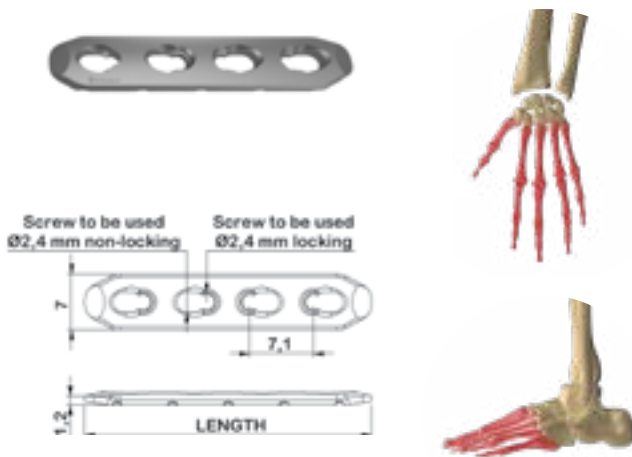

Screw to be used		
Ø (2,4 mm)		
TI	HOLES	LENGTH (mm)
O110 02 222 0006	4	36,0
O110 02 222 0008	5	43,6
O110 02 222 0010	6	51,2
O110 02 222 0012	7	58,8
O110 02 222 0014	8	66,4
O110 02 222 0016	10	81,6

2,4 mm Mini T Locking Plate (3 holes head)

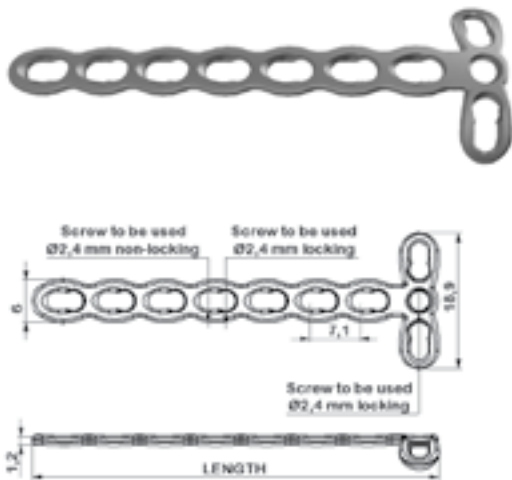

TI	SHAFT HOLES	HEAD HOLES	LENGTH (mm)
O110 02 222 0018	7	3	57



2,4 mm Mini Condylar Locking Plate

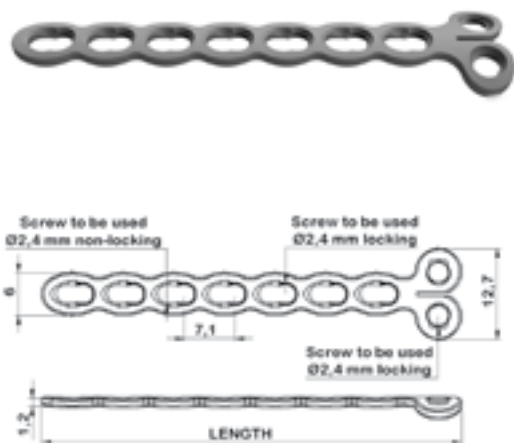

TI	SHAFT HOLES	HEAD HOLES	LENGTH (mm)
O110 02 222 0020	7	2	59



2,4 mm Mini Adaptation Locking Plate



TI	HOLES	LENGTH (mm)
O110 02 222 0022	12	87,9

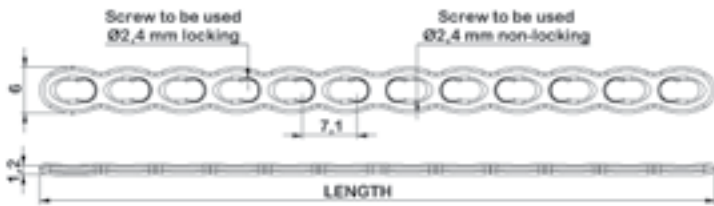

2,4 mm Mini Adaptation T Locking Plate (2 holes head)



TI	SHAFT HOLES	HEAD HOLES	LENGTH (mm)
O110 02 222 0024	7	2	59

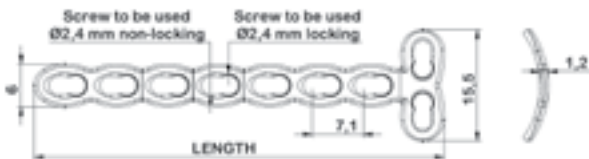

2,4 mm Mini Adaptation Y Locking Plate (3 holes head)



TI	SHAFT HOLES	HEAD HOLES	LENGTH (mm)
O310 02 043 0013	7	3	60,5

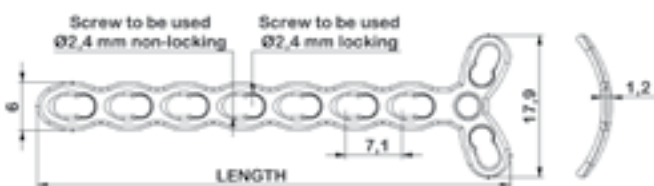



## 2,4 mm Mini Locking Screw

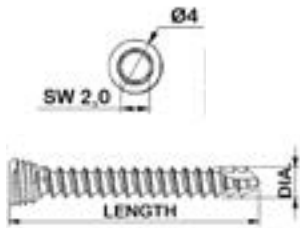

TI	DIA. x LENGTH (mm)
O110 03 213 0060	2,4X6,0
O100 03216 0070	2,4X7,0
O110 03 213 0080	2,4X8,0
O100 03216 0090	2,4X9,0
O110 03 213 0100	2,4X10
O100 03216 0011	2,4X11
O110 03 213 0120	2,4X12
O100 03216 0013	2,4X13
O110 03 213 0140	2,4X14
O100 03216 0015	2,4X15
O110 03 213 0160	2,4X16
O110 03 213 0180	2,4X18
O110 03 213 0200	2,4X20
O110 03 213 0220	2,4X22
O110 03 213 0240	2,4X24
O110 03 213 0260	2,4X26
O110 03 213 0280	2,4X28
O110 03 213 0300	2,4X30

## 2,4 mm Mini Screw

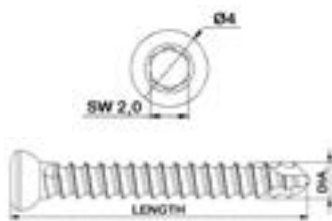

TI	DIA. x LENGTH (mm)
O1982306	2,4X6,0
O1982308	2,4X8,0
O1982310	2,4X10
O1982312	2,4X12
O1982314	2,4X14
O1982316	2,4X16
O1982318	2,4X18
O1982320	2,4X20
O1982322	2,4X22
O1982324	2,4X24
O1982326	2,4X26
O1982328	2,4X28
O1982330	2,4X30
O100 03216 0017	2,4X7,0
O100 03216 0019	2,4X9,0
O100 03216 0021	2,4X11
O100 03216 0023	2,4X13
O100 03216 0025	2,4X15

2,7 mm Mini Condylar Locking Plate



Screw to be used			
Ø (2,7 mm)			
TI	SHAFT HOLES	HEAD HOLES	LENGTH (mm)
O310 02 063 0002	7	2	66

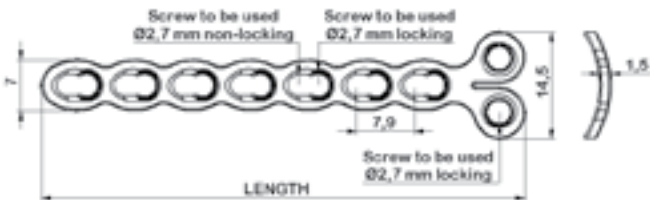

2,7 mm Mini Adaptation Locking Plate



TI	HOLES	LENGTH (mm)
O110 02 410 0012	12	97

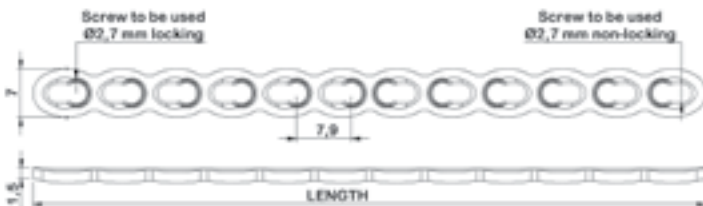

2,7 mm Mini T Locking Plate (2 holes head)



TI	SHAFT HOLES	HEAD HOLES	LENGTH (mm)
O310 02 062 0002	3	2	32
O310 02 062 0003	4	2	40

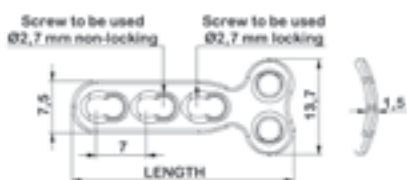

2,7 mm Mini Straight Locking Plate

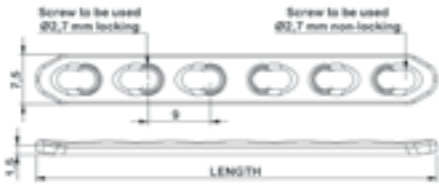

TI	HOLES	LENGTH (mm)
O110 02 410 0004	4	40
O110 02 410 0005	5	49
O110 02 410 0006	6	58
O110 02 410 0007	7	67
O110 02 410 0008	8	76
O110 02 410 0010	10	94



2,7 mm Mini L Locking Plate

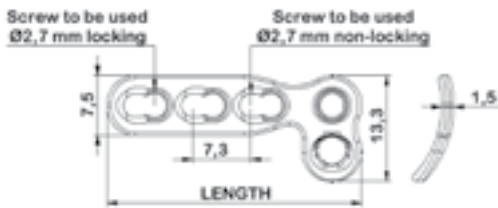

TI	SHAFT HOLES	HEAD HOLES	LENGTH (mm)	SIDE
O310 02 040 0003	3	2	32	Left
O310 02 041 0003	3	2	32	Right
O310 02 050 0003	4	2	40	Left
O310 02 050 0004	4	2	40	Right



2,7 mm Mini Oblique L Locking Plate

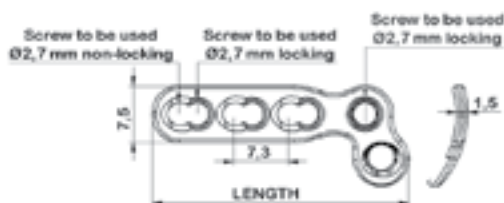

TI	SHAFT HOLES	HEAD HOLES	LENGTH (mm)	SIDE
O310 02 060 0003	3	2	35	Left
O310 02 061 0003	3	2	35	Right
O110 02 410 0002	4	2	42	Left
O110 02 410 0009	4	2	42	Right



## 2,7 mm Mini Locking Screw

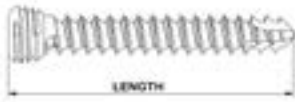

TI	DIA. x LENGTH (mm)	TI	DIA. x LENGTH (mm)
O1982710	2,7X10	O1982726	2,7X26
O1982712	2,7X12	O1982728	2,7X28
O1982714	2,7X14	O1982730	2,7X30
O1982716	2,7X16	O1982732	2,7X32
O1982718	2,7X18	O1982734	2,7X34
O1982720	2,7X20	O1982736	2,7X36
O1982722	2,7X22	O1982738	2,7X38
O1982724	2,7X24	O1982740	2,7X40

## 2,7 mm Mini Screw



TI	DIA. x LENGTH (mm)	TI	DIA. x LENGTH (mm)
O110 03 217 0100	2,7X10	O110 03 217 0260	2,7X26
O110 03 217 0120	2,7X12	O110 03 217 0280	2,7X28
O110 03 217 0140	2,7X14	O110 03 217 0300	2,7X30
O110 03 217 0160	2,7X16	O110 03 217 0320	2,7X32
O110 03 217 0180	2,7X18	O110 03 217 0340	2,7X34
O110 03 217 0200	2,7X20	O110 03 217 0360	2,7X36
O110 03 217 0220	2,7X22	O110 03 217 0380	2,7X38
O110 03 217 0240	2,7X24	O110 03 217 0400	2,7X40



# CHEST WALL PLATES & SCREWS

---

product  
group



Sternal Locking T Plate 2,9 mm



Screw to be used	Thickness (mm)	Width (mm)
Ø (2,9 mm)	2,8	7,2 - 15,9 7,2 - 21,3

TI	HOLES
O15408 128 07	7

TI	HOLES
O15408 128 08	8

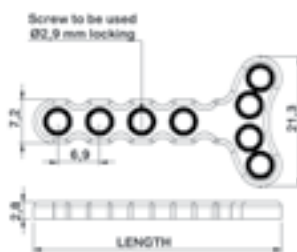
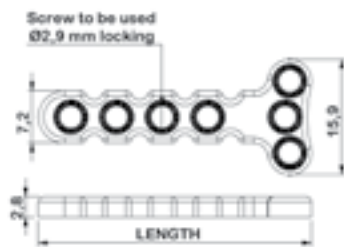

Sternal Locking I Plate 2,9 mm



Screw to be used	Thickness (mm)	Width (mm)
Ø (2,9 mm)	2,8	17,2 - 21,9

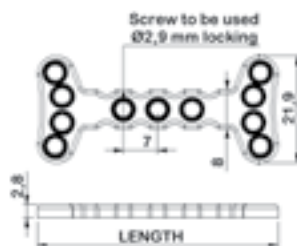
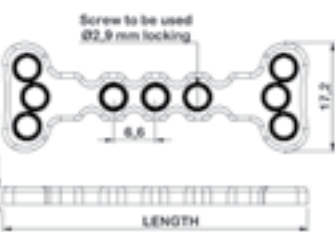

Sternal Locking Straight Plate 2,9 mm

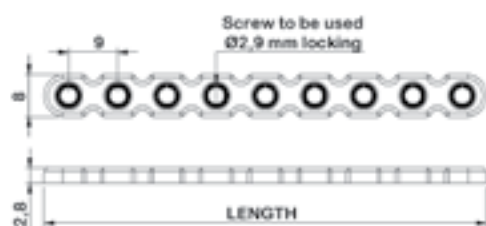

Screw to be used	Thickness (mm)	Width (mm)
Ø (2,9 mm)	2,8	8,0

TI	HOLES
O15408 2910	8
O15408 2912	9
O15408 2914	10



Universal Locking Straight Plate 2,9 mm

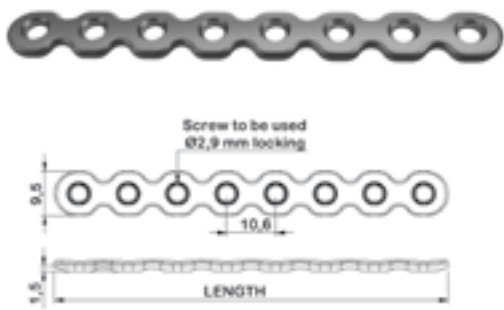

Screw to be used	Thickness (mm)	Width (mm)
Ø (2,9 mm)	1,5	9,5
TI	HOLES	
O15408 2916	8	
O15408 2918	24	
O15408 2920	30	

2,9 mm Self-Tapping Rib Locking Screw

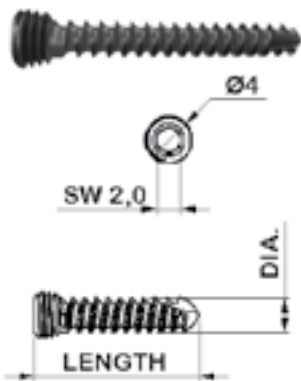

TI	DIA. x LENGTH (mm)
O15409 2906	2,9X6
O15409 2908	2,9X8
O15409 2910	2,9X10
O15409 2912	2,9X12
O15409 2914	2,9X14
O15409 2916	2,9X16
O15409 2918	2,9X18
O15409 2920	2,9X20

2,9 mm Self-Tapping Rib Screw

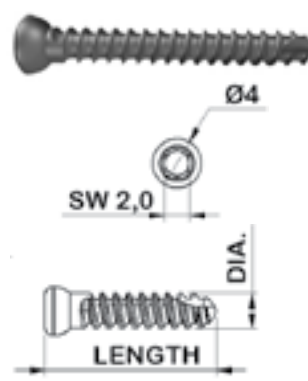

TI	DIA. x LENGTH (mm)
O15508 2910	2,9X10
O15508 2912	2,9X12

Rib Intramedullary Splints

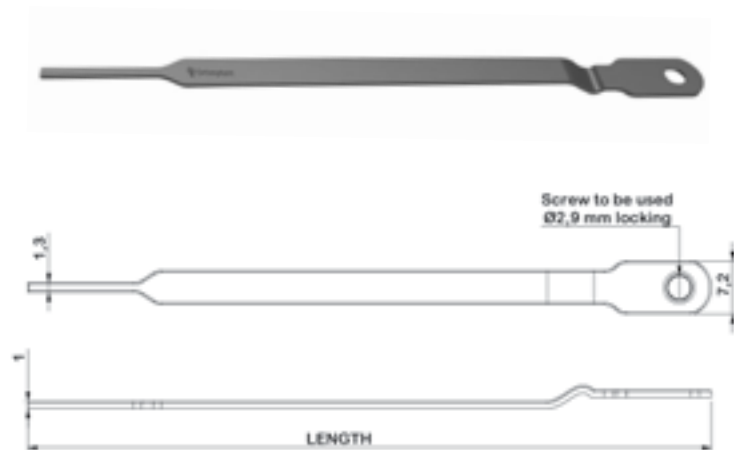

Screw to be used	Thickness (mm)	
Ø (2,9 mm)	1,0	
TI	WIDTH	LENGTH (mm)
O100 02 222 0003	3	50
O100 02 222 0004	4	50
O100 02 222 0005	5	50
O100 02 222 0006	3	65
O100 02 222 0007	4	65
O100 02 222 0008	5	65
O100 02 222 0009	3	80
O100 02 222 0010	4	80
O100 02 222 0011	5	80



\* DIA. Means DIAMETER



# LARGE FRAGMENT LOCKING PLATES

---

product  
group





4,5 / 5,0 mm Proximal Femur Locking Compression Plate 1

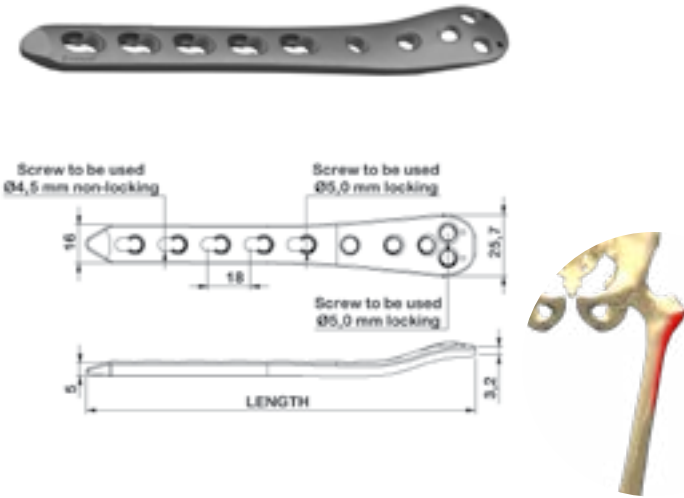

Screw to be used		Thickness (mm)	Width (mm)	
Ø (4,5 / 5,0 mm)		5,0	16,0 - 25,7	
SS	TI	HOLES	SIDE	LENGTH (mm)
O1120903	O1120803	3	Left	91,0
O1120905	O1120805	5	Left	126,8
O1120907	O1120807	7	Left	162,8
O1120909	O1120809	9	Left	198,8
O1120911	O1120811	11	Left	234,8
O1120913	O1120813	13	Left	270,8
O1130903	O1130803	3	Right	91,0
O1130905	O1130805	5	Right	126,8
O9130907	O1130807	7	Right	162,8
O1130909	O1130809	9	Right	198,8
O9130911	O1130811	11	Right	234,8
O1130913	O1130813	13	Right	270,8

4,5 / 5,0 / 7,3 mm Proximal Femur Locking Compression Plate 2

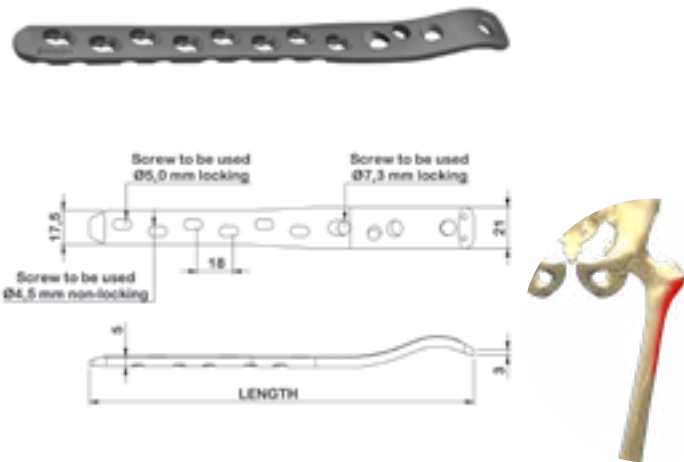

Screw to be used		Thickness (mm)	Width (mm)	
Ø (4,5mm / 5,0mm / 7,3mm)		5,0	17,5 - 21,0	
SS	TI	HOLES	SIDE	LENGTH (mm)
O1120902	O1120802	2	Left	119
O1120904	O1120804	4	Left	159
O1120906	O1120806	6	Left	195
O1120908	O1120808	8	Left	231
O1120910	O1120810	10	Left	267
O1130902	O1130802	2	Right	119
O1130904	O1130804	4	Right	159
O1130906	O1130806	6	Right	195
O1130908	O1130808	8	Right	231
O1130910	O1130914	10	Right	267

Proximal Femur Compression Plate 7,3 mm Cannulated Locking Screw

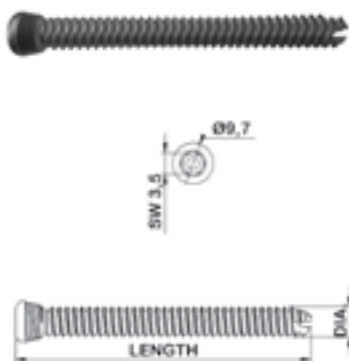

SS	TI	DIA. x LENGTH (mm)	SS	TI	DIA. x LENGTH (mm)
O6696050	O6666050	7,3xX50	O6696090	O6666090	7,3xX90,0
O6696055	O6666055	7,3xX55	O6696095	O6666095	7,3xX95,0
O6696060	O6666060	7,3xX60	O6696100	O6666100	7,3xX100
O6696065	O6666065	7,3xX65	O6696105	O6666105	7,3xX105
O6696070	O6666070	7,3xX70	O6696110	O6666110	7,3xX110
O6696075	O6666075	7,3xX75	O6696115	O6666115	7,3xX115
O6696080	O6666080	7,3xX80	O6696120	O6666120	7,3xX120
O6696085	O6666085	7,3xX85			

\* DIA. Means DIAMETER

4,5 / 5,0 mm Locking Plate Broad Curved

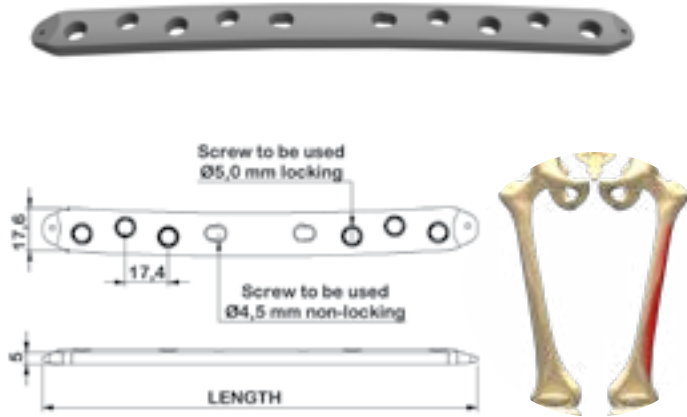

Screw to be used	Thickness (mm)	Width (mm)	
Ø (4,5 / 5,0 mm)	5,0	17,6	
SS	TI	HOLES	LENGTH (mm)
O1871909	O1871809	9	195,4
O1871910	O1871810	10	212,7
O1871911	O1872811	11	230,5
O1871912	O1872812	12	248,4
O1871913	O1872813	13	265,7
O1871914	O1872814	14	282,9
O1871915	O1872815	15	300,7
O1871916	O1872816	16	318,5

4,5 / 5,0 mm Distal Lateral Femur Locking Plate 1

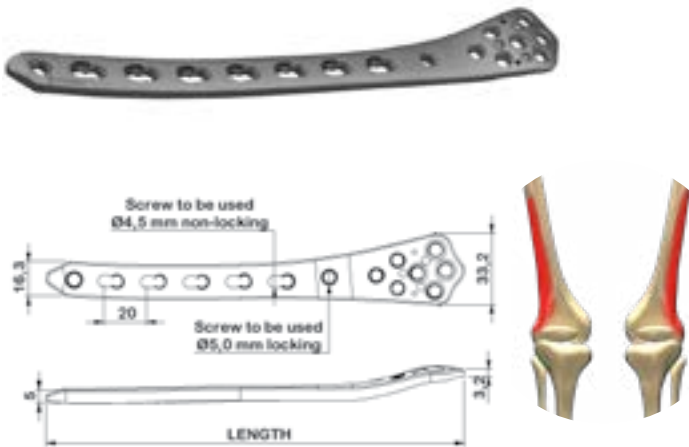

Screw to be used	Thickness (mm)	Width (mm)		
Ø (4,5 / 5,0 mm)	5,0	16,3 - 33,2		
SS	TI	HOLES	SIDE	LENGTH (mm)
O1441905	O1441805	5	Left	156,4
O1441907	O1441807	7	Left	196,4
O1441909	O1441809	9	Left	236,4
O1441911	O1441811	11	Left	276,4
O1441913	O1441813	13	Left	316,4
O1452905	O1452805	5	Right	156,4
O1452907	O1452807	7	Right	196,4
O1452909	O1452809	9	Right	236,4
O1452911	O1452811	11	Right	276,4
O1452913	O1452813	13	Right	316,4

4,5 / 5,0 mm Distal Lateral Femur Locking Plate 2

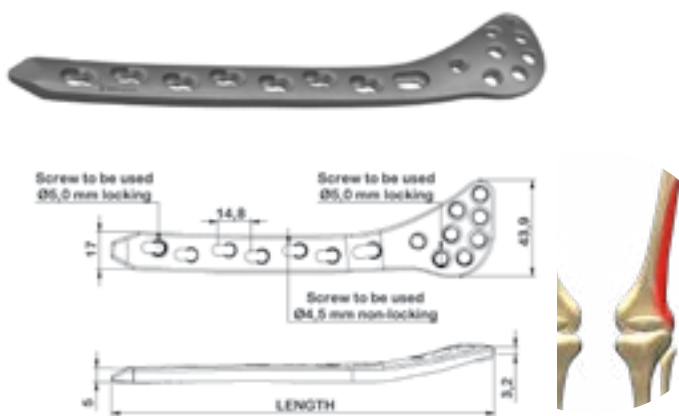

Screw to be used	Thickness (mm)	Width (mm)		
Ø (4,5 / 5,0 mm)	5,0	17,0 - 43,9		
SS	TI	HOLES	SIDE	LENGTH (mm)
O6729106	O6728106	6	Left	158
O6729107	O6728107	7	Left	174
O6729108	O6728108	8	Left	191
O6729109	O6728109	9	Left	206
O6729110	O6728110	10	Left	223
O6729112	O6728111	11	Left	250
O6729206	O6728206	6	Right	158
O6729207	O6728207	7	Right	174
O6729208	O6728208	8	Right	191
O6729209	O6728209	9	Right	206
O6729210	O6728210	10	Right	223
O6729211	O6728211	11	Right	250

4,5 / 5,0 mm Distal Medial Femur Locking Plate

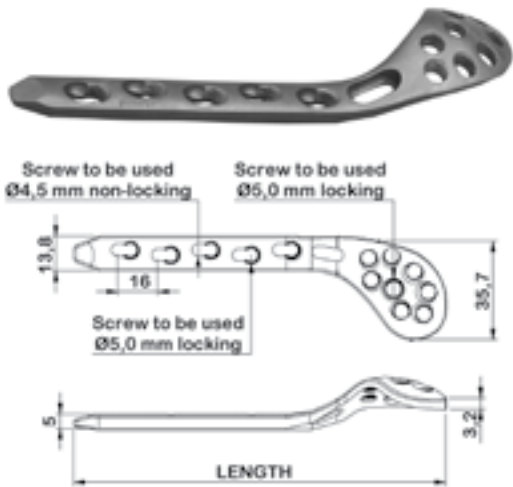

Screw to be used		Thickness (mm)	Width (mm)		
Ø (4,5 / 5,0 mm)		5,0	13,8 - 35,7		
SS	TI	HOLES	SIDE	LENGTH (mm)	
O6739104	O6738104	4	Left	115,9	
O6739106	O6738106	6	Left	147,9	
O6739108	O6738108	8	Left	179,9	
O6739110	O6738110	10	Left	211,9	
O6739204	O6738204	4	Right	115,9	
O6739206	O6738206	6	Right	147,9	
O6739208	O6738208	8	Right	179,9	
O6739210	O6738210	10	Right	211,9	

4,5 / 5,0 mm Condylar Femur Locking Plate

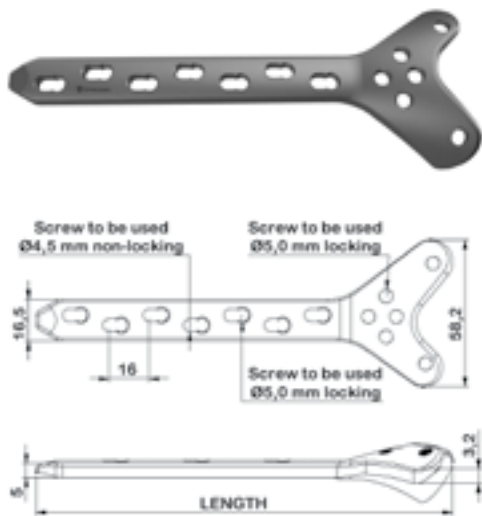

Screw to be used		Thickness (mm)	Width (mm)		
Ø (4,5 / 5,0 mm)		5,0	16,5 - 58,2		
SS	TI	HOLES	SIDE	LENGTH (mm)	
O6749106	O6748106	6	Left	149,1	
O6749108	O6748108	8	Left	181,1	
O6749110	O6748110	10	Left	213,1	
O6749112	O6748112	12	Left	245,1	
O6749206	O6748206	6	Right	149,1	
O6749208	O6748208	8	Right	181,1	
O6749210	O6748210	10	Right	213,1	
O6749212	O6748212	12	Right	245,1	

4,5 / 5,0 mm Proximal Lateral Tibia Locking Plate 1

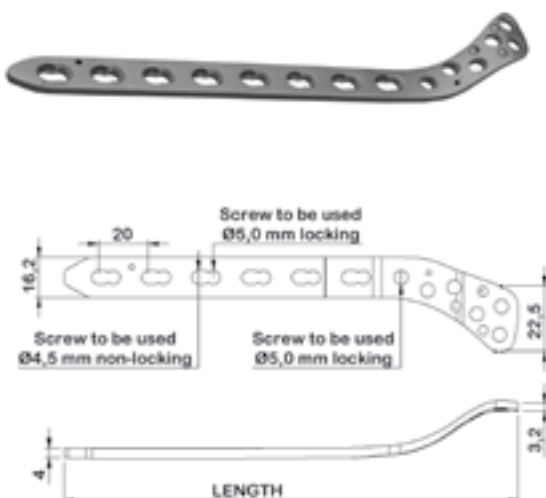

Screw to be used		Thickness (mm)	Width (mm)		
Ø (4,5 / 5,0 mm)		4,0	16,2 - 22,5		
SS	TI	HOLES	SIDE	LENGTH (mm)	
O1461905	O1461805	5	Left	143,3	
O1461907	O1461807	7	Left	183,3	
O1461909	O1461809	9	Left	223,3	
O1461911	O1461811	11	Left	263,3	
O1461913	O1461813	13	Left	303,3	
O1472905	O1472805	5	Right	143,3	
O1472907	O1472807	7	Right	183,3	
O1472909	O1472809	9	Right	223,3	
O1472911	O1472811	11	Right	263,3	
O1472913	O1472813	13	Right	303,3	

4,5 / 5,0 mm Proximal Lateral Tibia Locking Plate 2

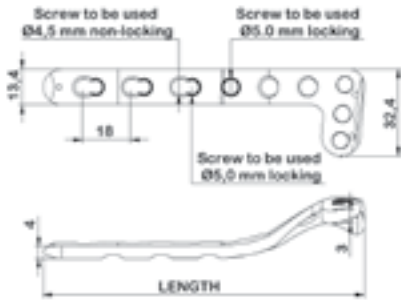

Screw to be used		Thickness (mm)	Width (mm)		
Ø (4,5 / 5,0 mm)		4,0	13,4 - 32,4		
SS	TI	HOLES	SIDE	LENGTH (mm)	
O9461905	O9461805	5	Left	102	
O9461907	O9461807	7	Left	138	
O9461909	O9461809	9	Left	174	
O9461911	O9461811	11	Left	210	
O9461913	O9461813	13	Left	246	
O9472905	O9472805	5	Right	102	
O9472907	O9472807	7	Right	138	
O9472909	O9472809	9	Right	174	
O9472911	O9472811	11	Right	210	
O9472913	O9472813	13	Right	246	

4,5 / 5,0 mm Proximal Medial Tibia Locking Plate

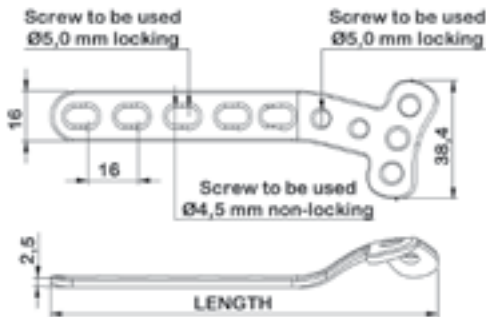

Screw to be used		Thickness (mm)	Width (mm)		
Ø (4,5 / 5,0 mm)		2,5	16,0 - 38,4		
SS	TI	HOLES	SIDE	LENGTH (mm)	
O5599104	O5598104	4	Left	90,6	
O5599106	O5598106	6	Left	122,6	
O5599108	O5598108	8	Left	154,6	
O5599110	O5598110	10	Left	186,6	
O5599112	O5598112	12	Left	218,6	
O5599204	O5598204	4	Right	90,6	
O5599206	O5598206	6	Right	122,6	
O5599208	O5598208	8	Right	154,6	
O5599210	O5598210	10	Right	186,6	
O5599212	O5598212	12	Right	218,6	

4,5 / 5,0 mm Locking Compression L - Plate

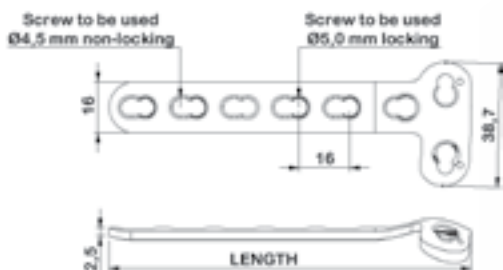

Screw to be used		Thickness (mm)	Width (mm)		
Ø (4,5 / 5,0 mm)		2,5	16,0 - 38,7		
SS	TI	HOLES	SIDE	LENGTH (mm)	
O1561903	O1561803	3	Left	65,1	
O1561904	O1561804	4	Left	81,1	
O1561905	O1561805	5	Left	97,1	
O1561906	O1561806	6	Left	113,1	
O1561907	O1561807	7	Left	129,1	
O1561908	O1561808	8	Left	145,1	
O1572903	O1572803	3	Right	65,1	
O1572904	O1572804	4	Right	81,1	
O1572905	O1572805	5	Right	97,1	
O1572906	O1572806	6	Right	113,1	
O1572907	O1572807	7	Right	129,1	
O1572908	O1572808	8	Right	145,1	

4,5 / 5,0 mm Locking Compression T - Plate

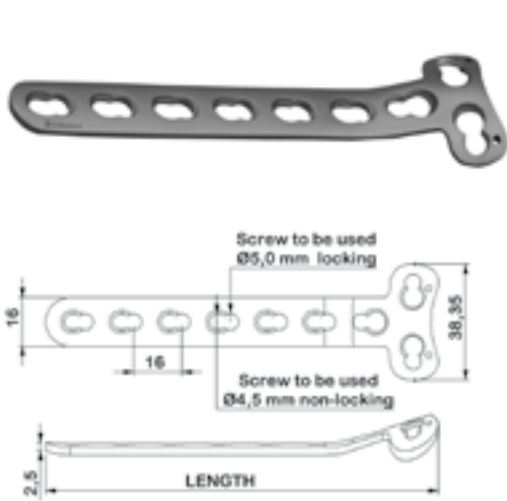

Screw to be used	Thickness (mm)	Width (mm)	
Ø (4,5 / 5,0 mm)	2,5	16,0 - 38,35	
SS	TI	HOLES	LENGTH (mm)
O1490904	O1490804	4	81,7
O1490905	O1490805	5	97,7
O1490906	O1490806	6	113,7
O1490907	O1490807	7	129,7
O1490908	O1490808	8	145,7

3,5 / 4,5 / 5,0 mm Metaphysis Locking Compression Plate

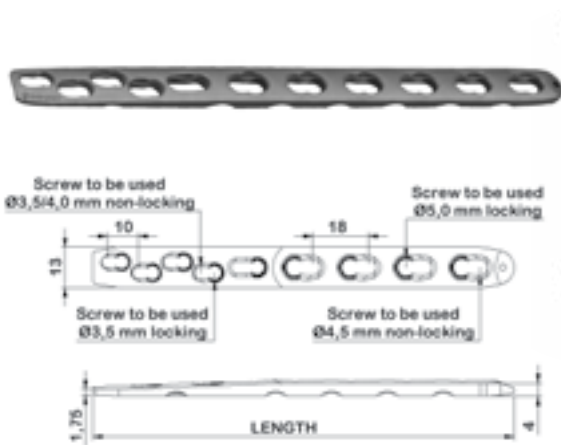

Screw to be used	Thickness (mm)	Width (mm)	
Ø (3,5 / 4,0 / 4,5 / 5,0 mm)	4,0	13,0	
SS	TI	HOLES	LENGTH (mm)
O1850903	O1850803	3	118
O1850904	O1850804	4	136
O1850905	O1850805	5	154
O1850906	O1850806	6	172
O1850907	O1850807	7	190
O1850908	O1850808	8	208
O1850909	O1850809	9	226
O1850911	O1850811	11	262

4,5 / 5,0 mm Narrow Locking Compression Plate

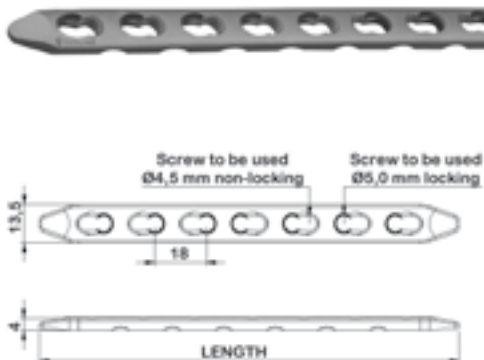

Screw to be used	Thickness (mm)	Width (mm)	
Ø (4,5 / 5,0 mm)	4,0	13,5	
SS	TI	HOLES	LENGTH (mm)
O1821105	O1820905	5	110,6
O1821106	O1820906	6	128,6
O1821107	O1820907	7	146,6
O1821108	O1820908	8	164,6
O1821109	O1820909	9	182,6
O1821110	O1820910	10	200,6
O1821111	O1820911	11	218,6
O1821112	O1820912	12	236,6
O1830816	O1820913	13	254,6
O1821114	O1820914	14	272,6

4,5 / 5,0 mm Broad Locking Compression Plate

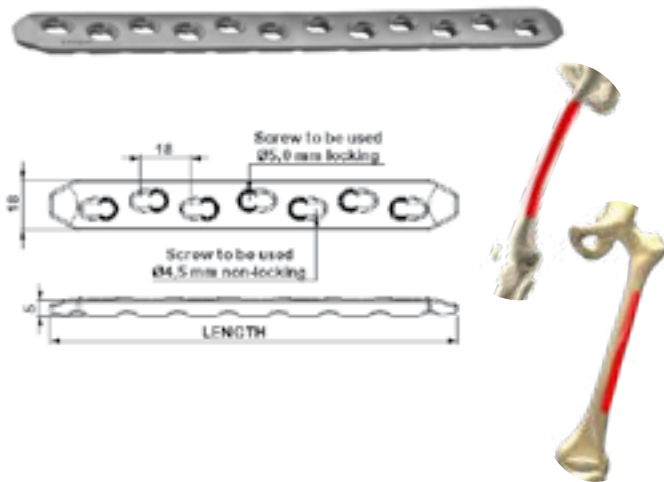

Screw to be used	Thickness (mm)	Width (mm)	
Ø (4,5 / 5,0 mm)	5,0	18,0	
SS	TI	HOLES	LENGTH (mm)
O1830905	O1830805	5	87
O1830906	O1830806	6	103
O1830907	O1830807	7	119
O1830908	O1830808	8	135
O1830909	O1830809	9	151
O1830910	O1830810	10	167
O1830911	O1830811	11	183
O1830912	O1830812	12	199
O1830913	O1830813	13	215
O1830914	O1830814	14	231

4,5 / 5,0 mm Distal Tibia Antrolateral Locking Plate 1

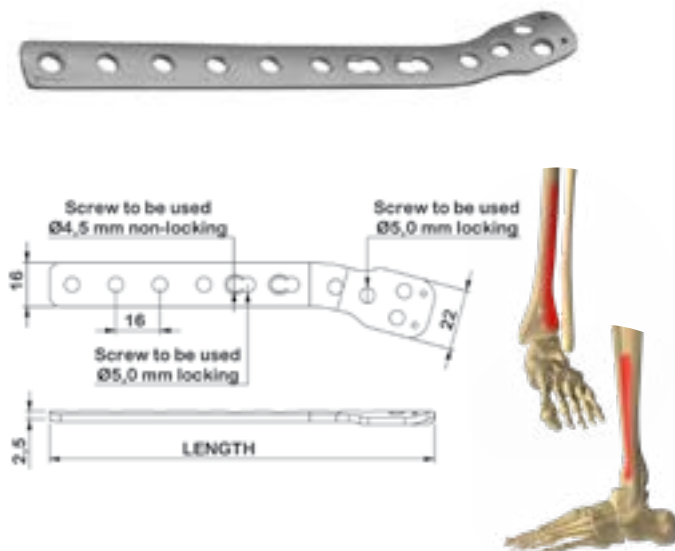

Screw to be used	Thickness (mm)	Width (mm)		
Ø (4,5 / 5,0 mm)	2,5	16,0 - 22,0		
SS	TI	HOLES	SIDE	LENGTH (mm)
O1261905	O1261805	5	Left	108,3
O1261907	O1261807	7	Left	140,3
O1261909	O1261809	9	Left	172,3
O1261911	O1261811	11	Left	204,3
O1261913	O1261813	13	Left	236,3
O1261915	O1261815	15	Left	268,3
O1272905	O1272805	5	Right	108,3
O1272907	O1272807	7	Right	140,3
O1272909	O1272809	9	Right	172,3
O1272911	O1272811	11	Right	204,3
O1272913	O1272813	13	Right	236,3
O1272915	O1272815	15	Right	268,3

Attachment Locking Plate Medium

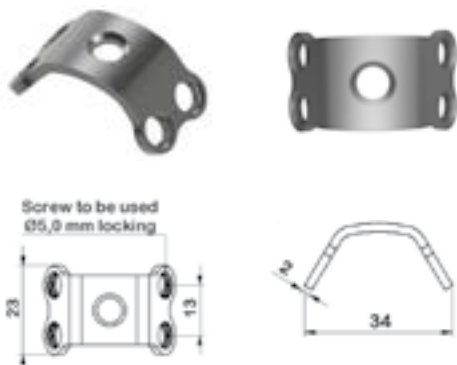

TI	TYPE	LENGTH (mm)
O110 02 190 0007	Medium	34

Attachment Locking Plate Large

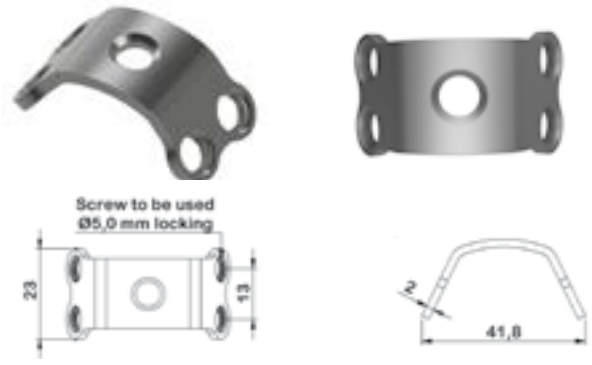

TI	TYPE	LENGTH (mm)
O110 02 190 0008	Large	41,8

3,5 / 4,0 mm Distal Tibia Antrolateral Locking Plate 2

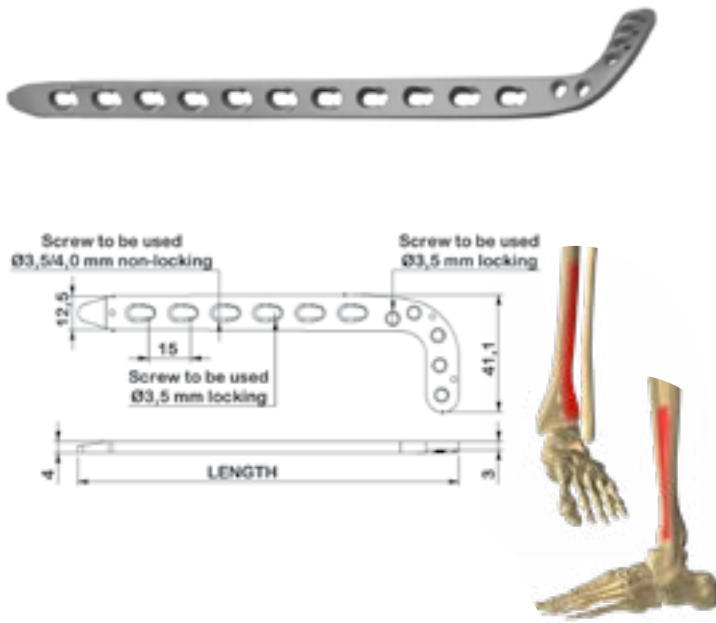

Screw to be used		Thickness (mm)	Width (mm)		
Ø (3,5 / 4,0 mm)		4,0	12,5 - 41,1		
SS	TI	HOLES	SIDE	LENGTH (mm)	
O1431905	O1431805	5	Left	89,8	
O1431907	O1431807	7	Left	119,8	
O1431909	O1431809	9	Left	149,8	
O1431911	O1431811	11	Left	179,8	
O1431913	O1431813	13	Left	209,8	
O1431915	O1431815	15	Left	239,8	
O1431917	O1431817	17	Left	269,8	
O1432905	O1432805	5	Right	89,8	
O1432907	O1432807	7	Right	119,8	
O1432909	O1432809	9	Right	149,8	
O1432911	O1432811	11	Right	179,8	
O1432913	O1432813	13	Right	209,8	
O1432915	O1432815	15	Right	239,8	
O1432917	O1432817	17	Right	269,8	

3,5 / 4,0 mm Distal Medial Tibia Locking Compression Plate 1

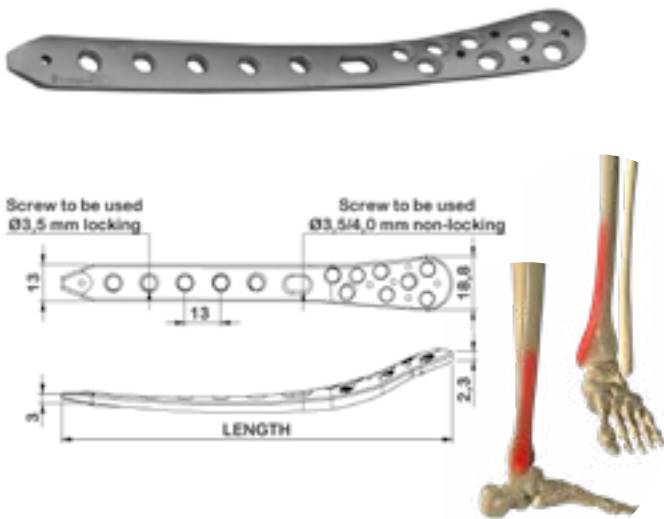

Screw to be used		Thickness (mm)	Width (mm)		
Ø (3,5 / 4,0 mm)		3,0	13,0 - 18,8		
SS	TI	HOLES	SIDE	LENGTH (mm)	
O1381904	O1381804	4	Left	116	
O1381906	O1381806	6	Left	142	
O1381908	O1381808	8	Left	168	
O1381910	O1381810	10	Left	194	
O1381912	O1381812	12	Left	220	
O1381914	O1381814	14	Left	246	
O1392904	O1392804	4	Right	116	
O1392906	O1392806	6	Right	142	
O1392908	O1392808	8	Right	168	
O1392910	O1392810	10	Right	194	
O1392912	O1392812	12	Right	220	
O1392914	O1392814	14	Right	246	

3,5 / 4,0 mm Distal Medial Tibia Locking Compression Plate 2

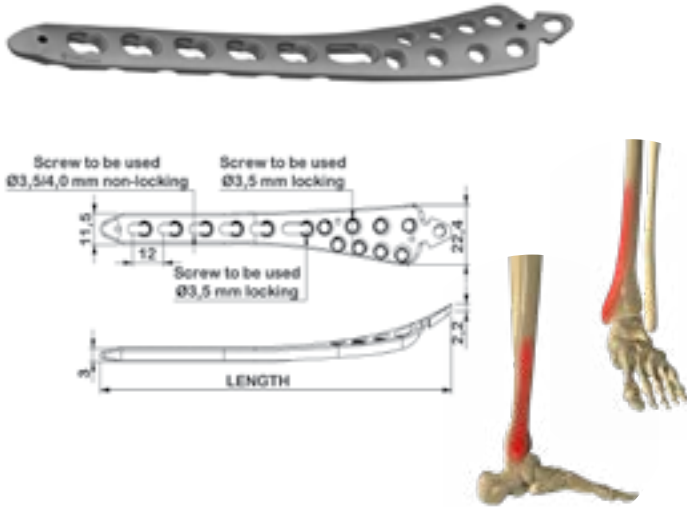

Screw to be used		Thickness (mm)	Width (mm)		
Ø (3,5 / 4,0 mm)		3,0	11,5 - 22,4		
SS	TI	HOLES	SIDE	LENGTH (mm)	
O1401906	O1401806	6	Left	137,9	
O1401908	O1401808	8	Left	161,9	
O1401910	O1401810	10	Left	185,9	
O1401912	O1401812	12	Left	209,9	
O1401914	O1401814	14	Left	233,9	
O1412906	O1412806	6	Right	137,9	
O1412908	O1412808	8	Right	161,9	
O1412910	O1412810	10	Right	185,9	
O1412912	O1412812	12	Right	209,9	
O1412914	O1412814	14	Right	233,9	

3,5 / 4,0 mm Distal Tibia Locking Pilon Plate

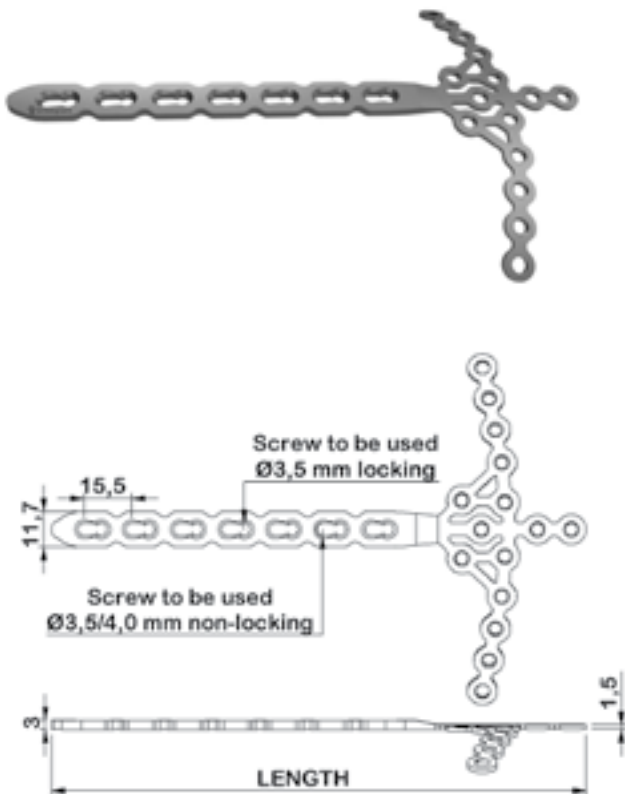

Screw to be used		Thickness (mm)	Width (mm)	
Ø (3,5 / 4,0 mm)		3,0	11,7	
SS	TI	HOLES	LENGTH (mm)	
O1411816	O1401816	16	111,5	
O1411818	O1401818	18	142,5	
O1411820	O1401820	20	173,5	
O1411822	O1401822	22	204,5	
O1411824	O1401824	24	235,5	
O1411826	O1401826	26	266,5	



3,5 / 4,0 mm Distal Fibula Locking Plate 1

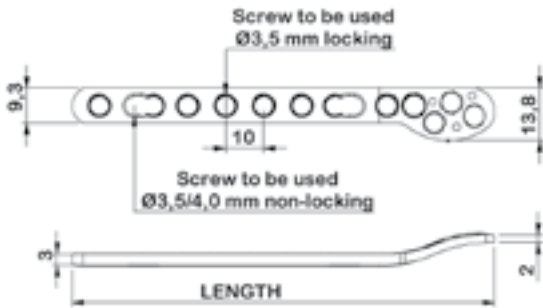

Screw to be used		Thickness (mm)	Width (mm)	
Ø (3,5 / 4,0 mm)		3,0	9,3 - 13,8	
SS	TI	HOLES	SIDE	LENGTH (mm)
O5097103	O5096103	3	Left	71
O5097104	O5096104	4	Left	81
O5097105	O5096105	5	Left	91
O5097106	O5096106	6	Left	101
O5097107	O5096107	7	Left	111
O5097108	O5096108	8	Left	121
O5097109	O5096109	9	Left	131
O5097110	O5096110	10	Left	141
O5097111	O5096111	11	Left	151
O5097112	O5096112	12	Left	161
O5097203	O5096203	3	Right	71
O5097204	O5096204	4	Right	81
O5097205	O5096205	5	Right	91
O5097206	O5096206	6	Right	101
O5097207	O5096207	7	Right	111
O5097208	O5096208	8	Right	121
O5097209	O5096209	9	Right	131
O5097210	O5096210	10	Right	141
O5097211	O5096211	11	Right	151
O5097212	O5096212	12	Right	161

2,7 / 3,5 / 4,0 mm Distal Fibula Locking Plate 2

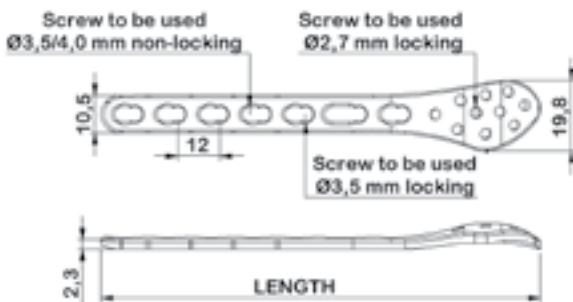

Screw to be used		Thickness (mm)	Width (mm)	
Ø (2,7 / 3,5 / 4,0 mm)		2,3	10,5 - 19,8	
SS	TI	HOLES	SIDE	LENGTH (mm)
O14319913	O14318813	3	Left	75,5
O14319914	O14318814	4	Left	87,5
O14319905	O14318805	5	Left	99,5
O14319906	O14318806	6	Left	111,5
O14319907	O14318807	7	Left	123,5
O14319908	O14318808	8	Left	135,5
O14319909	O14318809	9	Left	147,5
O14319910	O14318810	10	Left	159,5
O14319911	O14318811	11	Left	171,5
O14319912	O14318812	12	Left	183,5
O14329913	O14328813	3	Right	75,5
O14329914	O14328814	4	Right	87,5
O14329905	O14328805	5	Right	99,5
O14329906	O14328806	6	Right	111,5
O14329907	O14328807	7	Right	123,5
O14329908	O14328808	8	Right	135,5
O14329909	O14328809	9	Right	147,5
O14329910	O14328810	10	Right	159,5
O14329911	O14328811	11	Right	171,5
O14329912	O14328812	12	Right	183,5

4,0 / 4,5 / 5,0 mm Reconstruction Locking Compression Plate

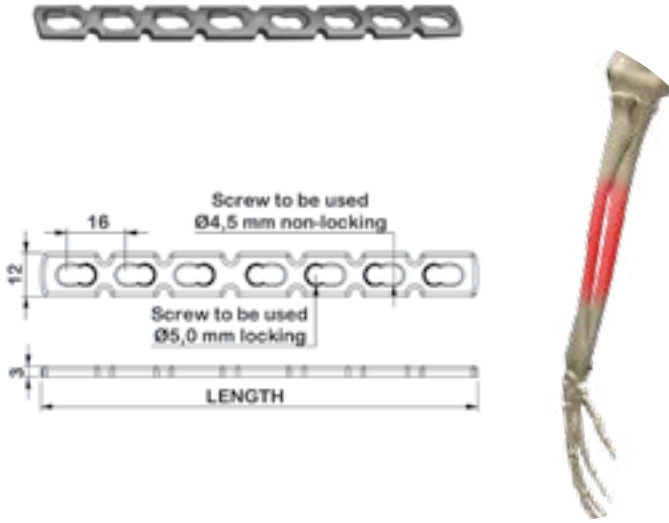

Screw to be used	Thickness (mm)	Width (mm)	
Ø (4,0 / 4,5 / 5,0 mm)	3,0	12,0	
SS	TI	HOLES	LENGTH (mm)
O1810905	O1810805	5	86
O1810906	O1810806	6	102
O1810907	O1810807	7	118
O1810908	O1810808	8	134
O1810909	O1810809	9	150
O1810910	O1810810	10	166
O1810912	O1810812	12	198

5,0 mm Curved Reconstruction Locking Plate

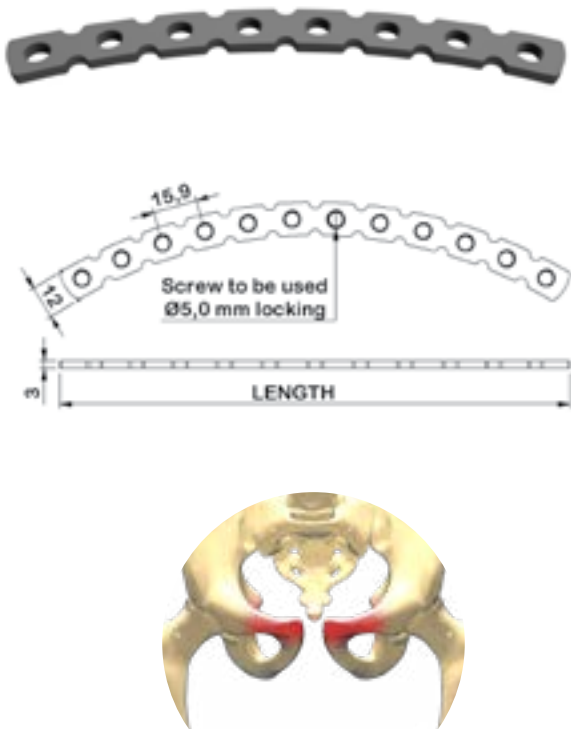

Screw to be used	Thickness (mm)	Width (mm)	
Ø (5,0 mm)	3,0	12,0	
SS	TI	HOLES	LENGTH (mm)
O101 02 228 0002	O111 02 228 0002	2	30
O101 02 228 0003	O111 02 228 0003	3	45
O101 02 228 0004	O111 02 228 0004	4	61
O101 02 228 0005	O111 02 228 0005	5	78
O101 02 228 0006	O111 02 228 0006	6	94
O101 02 228 0007	O111 02 228 0007	7	109
O101 02 228 0008	O111 02 228 0008	8	125
O101 02 228 0009	O111 02 228 0009	9	140
O101 02 228 0010	O111 02 228 0010	10	155
O101 02 228 0011	O111 02 228 0011	11	169
O101 02 228 0012	O111 02 228 0012	12	184

3,5 / 4,0 mm Calcaneal Locking Plate

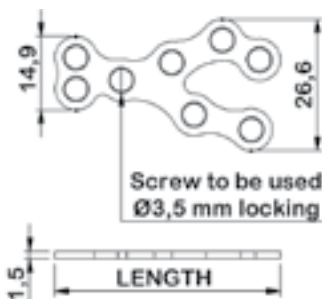
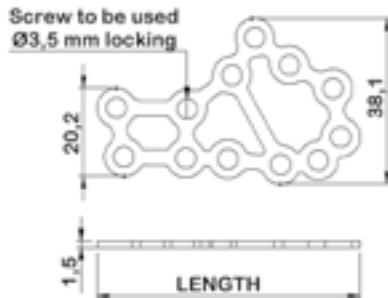
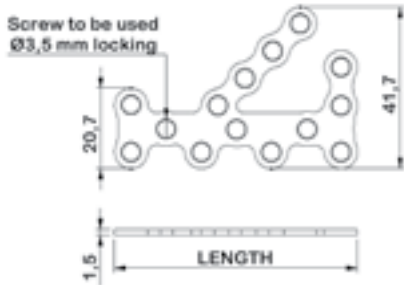

Calcaneal Locking Plate 1

Screw to be used	Thickness (mm)	Width (mm)	
Ø (3,5 / 4,0 mm)	1,5	20,7 - 41,7	
SS	TI	SIDE	LENGTH (mm)
O5989100	O5988100	Left	62,6
O5989101	O5988101	Right	62,6



Calcaneal Locking Plate 2

Screw to be used	Thickness (mm)	Width (mm)	
Ø (3,5 / 4,0 mm)	1,5	20,2 - 38,1	
SS	TI	SIDE	LENGTH (mm)
O5999100	O5998100	Left	60,5
O5999101	O5998101	Right	60,5



Calcaneal Locking Plate 3

Screw to be used	Thickness (mm)	Width (mm)	
Ø (3,5 / 4,0 mm)	1,5	14,9 - 26,6	
SS	TI	SIDE	LENGTH (mm)
O5979100	O5978100	Left	45,7
O5979101	O5978101	Right	45,7



## 3,5 / 4,0 mm Calcaneal Locking Plate

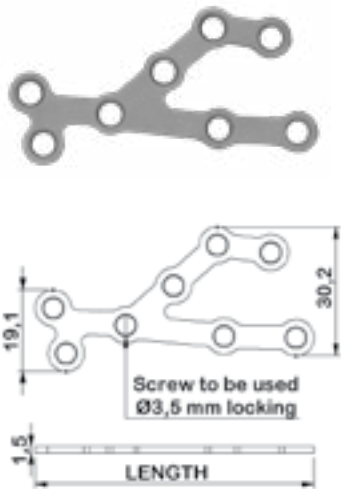

## Calcaneal Locking Plate 4

Screw to be used	Thickness (mm)	Width (mm)	
Ø (3,5 / 4,0 mm)	1,5	19,1 - 30,2	
SS	TI	SIDE	LENGTH (mm)
O5969100	O5968100	Left	65,6
O5969101	O5968101	Right	65,6

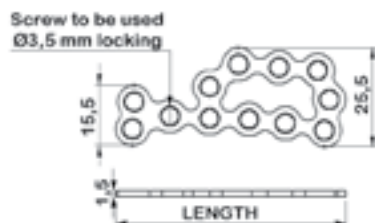

## Calcaneal Locking Plate 5

Screw to be used	Thickness (mm)	Width (mm)	
Ø (3,5 / 4,0 mm)	1,5	15,5 - 25,5	
SS	TI	SIDE	LENGTH (mm)
O5959100	O5958100	Left	59,1
O5959101	O5958101	Right	59,1





# LARGE FRAGMENT LOCKING SCREWS

---

product  
group



## 5,0 mm Self - Tapping Locking Screw

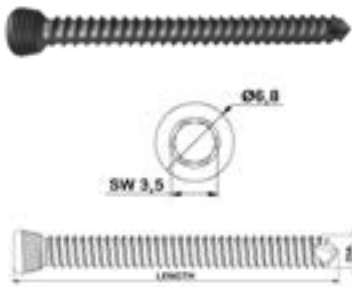

SS	TI	DIA. x LENGTH (mm)	SS	TI	DIA. x LENGTH (mm)
O2095014	O2085014	5,0X14	O2095040	O2085040	5,0X40
O2095016	O2085016	5,0X16	O2095042	O2085042	5,0X42
O2095018	O2085018	5,0X18	O2095044	O2085044	5,0X44
O2095020	O2085020	5,0X20	O2095046	O2085046	5,0X46
O2095022	O2085022	5,0X22	O2095048	O2085048	5,0X48
O2095024	O2085024	5,0X24	O2095050	O2085050	5,0X50
O2095026	O2085026	5,0X26	O2095055	O2085055	5,0X55
O2095028	O2085028	5,0X28	O2095060	O2085060	5,0X60
O2095030	O2085030	5,0X30	O2095065	O2085065	5,0X65
O2095032	O2085032	5,0X32	O2095070	O2085070	5,0X70
O2095034	O2085034	5,0X34	O2095075	O2085075	5,0X75
O2095036	O2085036	5,0X36	O2095080	O2085080	5,0X80
O2095038	O2085038	5,0X38	O2095085	O2085085	5,0X85
			O2095090	O2085090	5,0X90

## 5,0 mm Locking Cancellous Screw Full Threaded

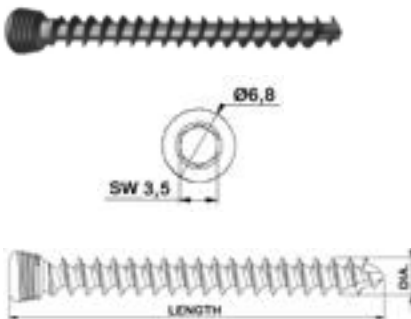

SS	TI	DIA. x LENGTH (mm)	SS	TI	DIA. x LENGTH (mm)
O33802035	O33702035	5,0X35	O33802075	O33702075	5,0X75
O33802040	O33702040	5,0X40	O33802080	O33702080	5,0X80
O33802045	O33702045	5,0X45	O33802085	O33702085	5,0X85
O33802050	O33702050	5,0X50	O33802090	O33702090	5,0X90
O33802055	O33702055	5,0X55	O33802095	O33702095	5,0X95
O33802060	O33702060	5,0X60	O33802100	O33702100	5,0X100
O33802065	O33702065	5,0X65	O33802105	O33702105	5,0X105
O33802070	O33702070	5,0X70	O33802110	O33702110	5,0X110

## 5,0 mm Locking Cancellous Screw Partially Threaded

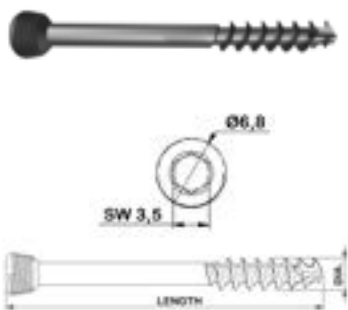

SS	TI	DIA. x LENGTH (mm)	SS	TI	DIA. x LENGTH (mm)
O33801035	O33701035	5,0X35	O33801075	O33701075	5,0X75
O33801040	O33701040	5,0X40	O33801080	O33701080	5,0X80
O33801045	O33701045	5,0X45	O33801085	O33701085	5,0X85
O33801050	O33701050	5,0X50	O33801090	O33701090	5,0X90
O33801055	O33701055	5,0X55	O33801095	O33701095	5,0X95
O33801060	O33701060	5,0X60	O33801100	O33701100	5,0X100
O33801065	O33701065	5,0X65	O33801105	O33701105	5,0X105
O33801070	O33701070	5,0X70	O33801110	O33701110	5,0X110

5,0 mm Self - Drilling Locking Screw



SS	TI	DIA. x LENGTH (mm)
O2495018	O2485018	5,0X18
O2495020	O2485020	5,0X20
O2495022	O2485022	5,0X22
O2495024	O2485024	5,0X24
O2495026	O2485026	5,0X26
O2495028	O2485028	5,0X28
O2495030	O2485030	5,0X30
O2495032	O2485032	5,0X32
O2495034	O2485034	5,0X34
O2495036	O2485036	5,0X36
O2495038	O2485038	5,0X38
O2495040	O2485040	5,0X40
O2495042	O2485042	5,0X42
O2495044	O2485044	5,0X44
O2495046	O2485046	5,0X46
O2495048	O2485048	5,0X48
O2495050	O2485050	5,0X50
O2495055	O2485055	5,0X55
O2495060	O2485060	5,0X60
O2495065	O2485065	5,0X65
O2495070	O2485070	5,0X70
O2495075	O2485075	5,0X75
O2495080	O2485080	5,0X80
O2495085	O2485085	5,0X85
O2495090	O2485090	5,0X90

5,0 mm Cable Locking Screw



TI  
O900 03 020 0008

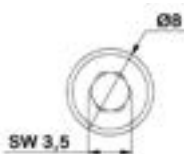

Locking Screw Plug



TI  
O900 03 020 0009

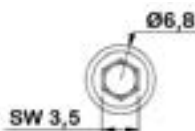

\* DIA. Means DIAMETER

## 6,5 mm Locking Cancellous Screw Full Threaded

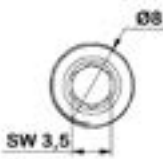

SS	TI	DIA. x LENGTH (mm)
O34865035	O34765035	6,5X35
O34865040	O34765040	6,5X40
O34865045	O34765045	6,5X45
O34865050	O34765050	6,5X50
O34865055	O34765055	6,5X55
O34865060	O34765060	6,5X60
O34865065	O34765065	6,5X65
O34865070	O34765070	6,5X70
O34865075	O34765075	6,5X75
O34865080	O34765080	6,5X80
O34865085	O34765085	6,5X85
O34865090	O34765090	6,5X90
O34865095	O34765095	6,5X95
O34865100	O34765100	6,5X100
O34865105	O34765105	6,5X105
O34865110	O34765110	6,5X110

## 6,5 mm Locking Cancellous Screw 16 mm Threaded

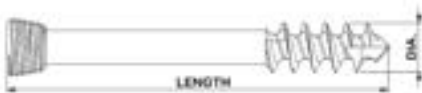
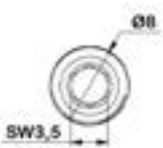

SS	TI	DIA. x LENGTH (mm)
O34867035	O34767035	6,5X35
O34867040	O34767040	6,5X40
O34867045	O34767045	6,5X45
O34867050	O34767050	6,5X50
O34867055	O34767055	6,5X55
O34867060	O34767060	6,5X60
O34867065	O34767065	6,5X65
O34867070	O34767070	6,5X70
O34867075	O34767075	6,5X75
O34867080	O34767080	6,5X80
O34867085	O34767085	6,5X85
O34867090	O34767090	6,5X90
O34867095	O34767095	6,5X95
O34867100	O34767100	6,5X100
O34867105	O34767105	6,5X105
O34867110	O34767110	6,5X110



## 6,5 mm Locking Cancellous Screw 32 mm Threaded

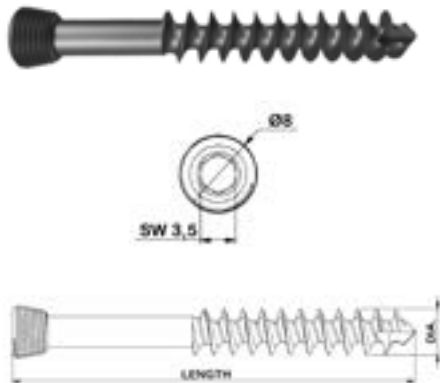

SS	TI	DIA. x LENGTH (mm)
O34866045	O34766045	6,5X45
O34866050	O34766050	6,5X50
O34866055	O34766055	6,5X55
O34866060	O34766060	6,5X60
O34866065	O34766065	6,5X65
O34866070	O34766070	6,5X70
O34866075	O34766075	6,5X75
O34866080	O34766080	6,5X80
O34866085	O34766085	6,5X85
O34866090	O34766090	6,5X90
O34866095	O34766095	6,5X95
O34866100	O34766100	6,5X100
O34866105	O34766105	6,5X105
O34866110	O34766110	6,5X110

## 5,0 mm Self - Tapping Locking Cannulated Screw



SS	TI	DIA. x LENGTH (mm)
O2045014	O2055014	5,0X14
O2045016	O2055016	5,0X16
O2045018	O2055018	5,0X18
O2045020	O2055020	5,0X20
O2045022	O2055022	5,0X22
O2045024	O2055024	5,0X24
O2045026	O2055026	5,0X26
O2045028	O2055028	5,0X28
O2045030	O2055030	5,0X30
O2045032	O2055032	5,0X32
O2045034	O2055034	5,0X34
O2045036	O2055036	5,0X36
O2045038	O2055038	5,0X38
O2045040	O2055040	5,0X40
O2045042	O2055042	5,0X42
O2045044	O2055044	5,0X44
O2045046	O2055046	5,0X46
O2045048	O2055048	5,0X48
O2045050	O2055050	5,0X50
O2045055	O2055055	5,0X55
O2045060	O2055060	5,0X60
O2045065	O2055065	5,0X65
O2045070	O2055070	5,0X70
O2045075	O2055075	5,0X75
O2045080	O2055080	5,0X80
O2045085	O2055085	5,0X85
O2045090	O2055090	5,0X90



# LARGE FRAGMENT NON LOCKING PLATES

---

product  
group



4,5 mm Proximal Femur Compression Plate 1

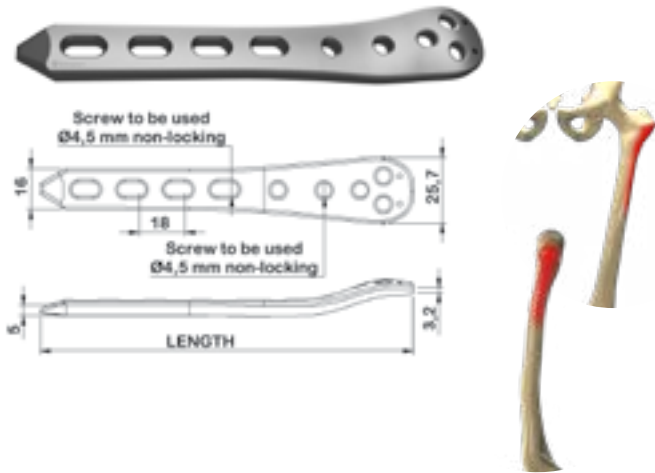

Screw to be used		Thickness (mm)		Width (mm)		
Ø (4,5 mm)		5,0		16 - 25,7		
SS	TI	HOLES	SIDE	LENGTH (mm)		
O100 02 252 0005	O110 02 252 0005	5	Left	126,8		
O100 02 252 0007	O110 02 252 0007	7	Left	162,8		
O100 02 252 0009	O110 02 252 0009	9	Left	198,8		
O100 02 252 0011	O110 02 252 0011	11	Left	234,8		
O100 02 252 0013	O110 02 252 0013	13	Left	270,8		
O100 02 253 0005	O110 02 253 0005	5	Right	126,8		
O100 02 253 0007	O110 02 253 0007	7	Right	162,8		
O100 02 253 0009	O110 02 253 0009	9	Right	198,8		
O100 02 253 0011	O110 02 253 0011	11	Right	234,8		
O100 02 253 0013	O110 02 253 0013	13	Right	270,8		

4,5 mm Distal Lateral Femur Plate 1

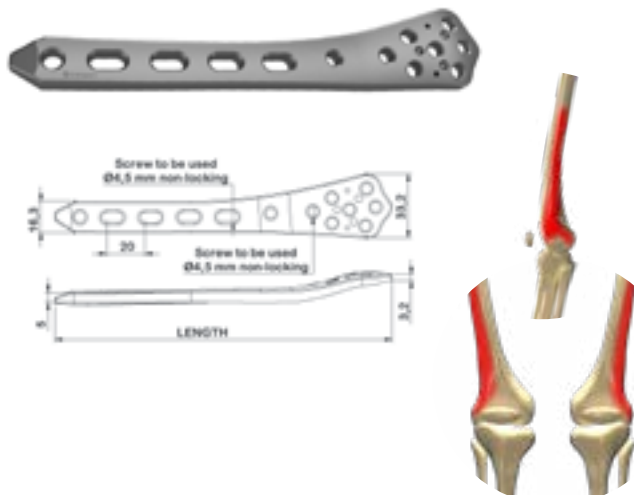

Screw to be used		Thickness (mm)		Width (mm)		
Ø (4,5 mm)		5,0		16,3 - 33,2		
SS	TI	HOLES	SIDE	LENGTH (mm)		
O100 02 245 0005	O110 02 245 0005	5	Left	156,4		
O100 02 245 0007	O110 02 245 0007	7	Left	194,4		
O100 02 245 0009	O110 02 245 0009	9	Left	236,4		
O100 02 245 0011	O110 02 245 0011	11	Left	276,4		
O100 02 245 0013	O110 02 245 0013	13	Left	306,4		
O100 02 246 0005	O110 02 246 0005	5	Right	156,4		
O100 02 246 0007	O110 02 246 0007	7	Right	196,4		
O100 02 246 0009	O110 02 246 0009	9	Right	236,4		
O100 02 246 0011	O110 02 246 0011	11	Right	276,4		
O100 02 246 0013	O110 02 246 0013	13	Right	306,4		

4,5 mm Distal Lateral Femur Plate 2

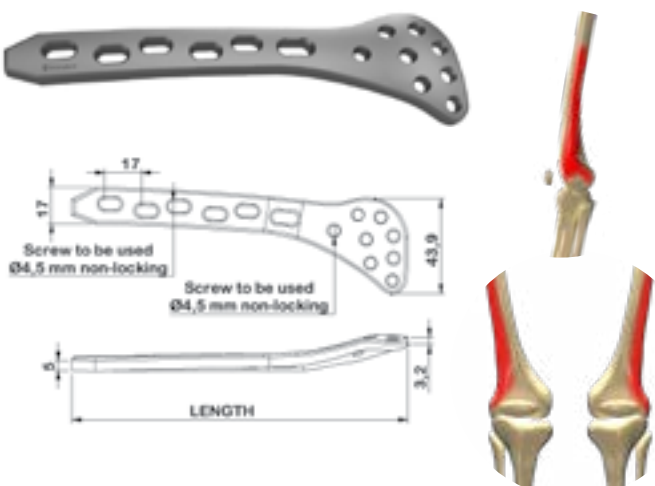

Screw to be used		Thickness (mm)		Width (mm)		
Ø (4,5 mm)		5,0		17 - 43,9		
SS	TI	HOLES	SIDE	LENGTH (mm)		
O5729206	O5728206	6	Left	158		
O5729207	O5728207	7	Left	174		
O5729208	O5728208	8	Left	191		
O5729209	O5728209	9	Left	206		
O5729210	O5728210	10	Left	223		
O5729212	O5728212	12	Left	250		
O5729106	O5728106	6	Right	158		
O5729107	O5728107	7	Right	174		
O5729108	O5728108	8	Right	191		
O5729109	O5728109	9	Right	206		
O5729110	O5728110	10	Right	223		
O5729112	O5728112	12	Right	250		

4,5 / 6,5 mm Femur Condylar Buttress Plate

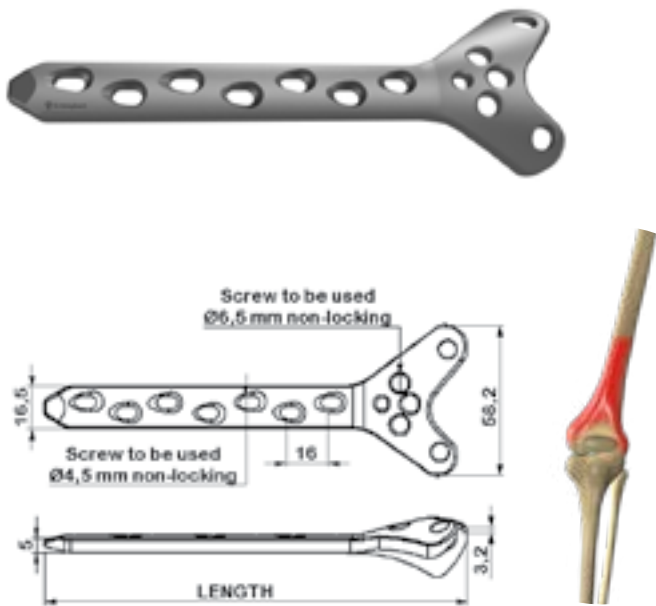

Screw to be used		Thickness (mm)	Width (mm)		
Ø (4,5 / 6,5 mm)		5,0	16,5 - 58,2		
SS	TI	HOLES	SIDE	LENGTH (mm)	
O100 02 186 0005	O110 02 186 0005	5	Left	133	
O100 02 186 0006	O110 02 186 0006	6	Left	149	
O100 02 186 0007	O110 02 186 0007	7	Left	165	
O100 02 186 0008	O110 02 186 0008	8	Left	181	
O100 02 186 0009	O110 02 186 0009	9	Left	197	
O100 02 186 0010	O110 02 186 0010	10	Left	213	
O100 02 186 0011	O110 02 186 0011	11	Left	229	
O100 02 186 0012	O110 02 186 0012	12	Left	245	
O100 02 186 0013	O110 02 186 0013	13	Left	264	
O100 02 186 0014	O110 02 186 0014	14	Left	277	
O100 02 186 0015	O110 02 186 0015	15	Left	293	
O100 02 185 0005	O110 02 185 0005	5	Right	133	
O100 02 185 0006	O110 02 185 0006	6	Right	149	
O100 02 185 0007	O110 02 185 0007	7	Right	165	
O100 02 185 0008	O110 02 185 0008	8	Right	181	
O100 02 185 0009	O110 02 185 0009	9	Right	197	
O100 02 185 0010	O110 02 185 0010	10	Right	213	
O100 02 185 0011	O110 02 185 0011	11	Right	229	
O100 02 185 0012	O110 02 185 0012	12	Right	245	
O100 02 185 0013	O110 02 185 0013	13	Right	264	
O100 02 185 0014	O110 02 185 0014	14	Right	277	
O100 02 185 0015	O110 02 185 0015	15	Right	293	

4,5 mm Distal Medial Femur Buttress Plate

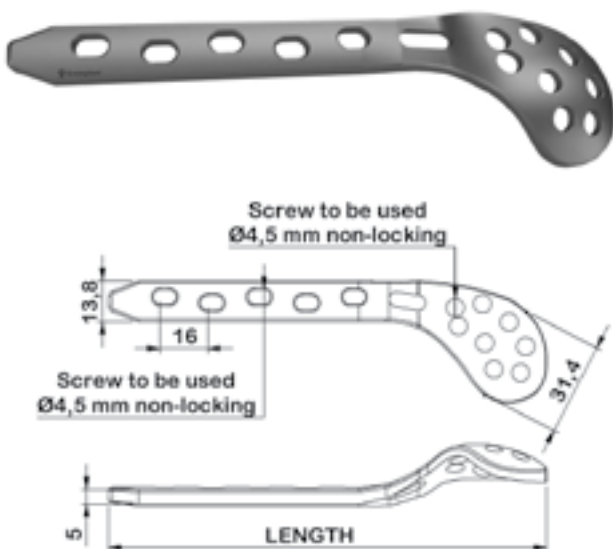

Screw to be used		Thickness (mm)	Width (mm)		
Ø (4,5 mm)		5,0	13,8 - 31,4		
SS	TI	HOLES	SIDE	LENGTH (mm)	
O5739104	O5738104	4	Left	115,9	
O5739106	O5738106	6	Left	147,9	
O5739108	O5738108	8	Left	179,9	
O5739204	O5738204	4	Right	115,9	
O5739206	O5738206	6	Right	147,9	
O5739208	O5738208	8	Right	179,9	

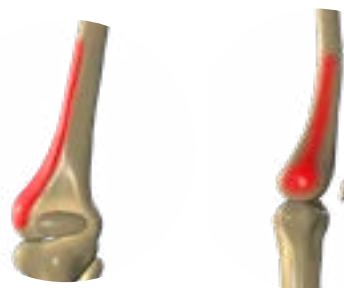

4,5 / 6,5 mm Broad Compression Plate

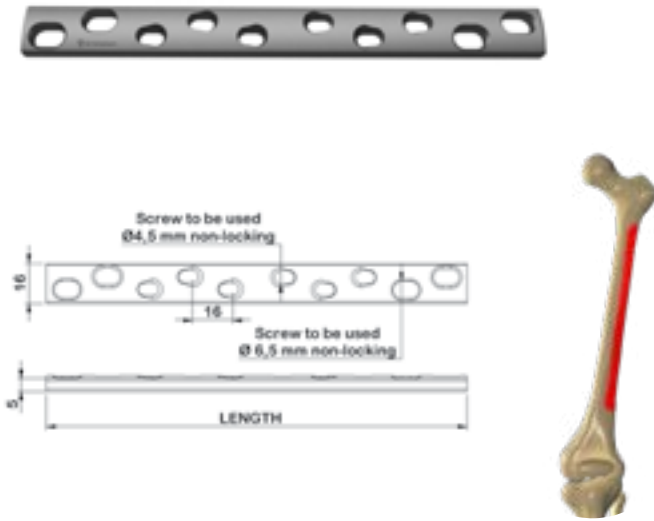

Screw to be used	Thickness (mm)	Width (mm)	
Ø (4,5 / 6,5 mm)	5,0	16,0	
SS	Ti	HOLES	LENGTH (mm)
O100 02 161 0004	O110 02 161 0004	4	71
O100 02 161 0005	O110 02 161 0005	5	87
O100 02 161 0006	O110 02 161 0006	6	103
O100 02 161 0007	O110 02 161 0007	7	119
O100 02 161 0008	O110 02 161 0008	8	135
O100 02 161 0009	O110 02 161 0009	9	151
O100 02 161 0010	O110 02 161 0010	10	167
O100 02 161 0011	O110 02 161 0011	11	183
O100 02 161 0012	O110 02 161 0012	12	199
O100 02 161 0013	O110 02 161 0013	13	215
O100 02 161 0014	O110 02 161 0014	14	231
O100 02 161 0015	O110 02 161 0015	15	247
O100 02 161 0016	O110 02 161 0016	16	263
O100 02 161 0017	O110 02 161 0017	17	279
O100 02 161 0018	O110 02 161 0018	18	295

4,5 / 6,5 mm Narrow Compression Plate

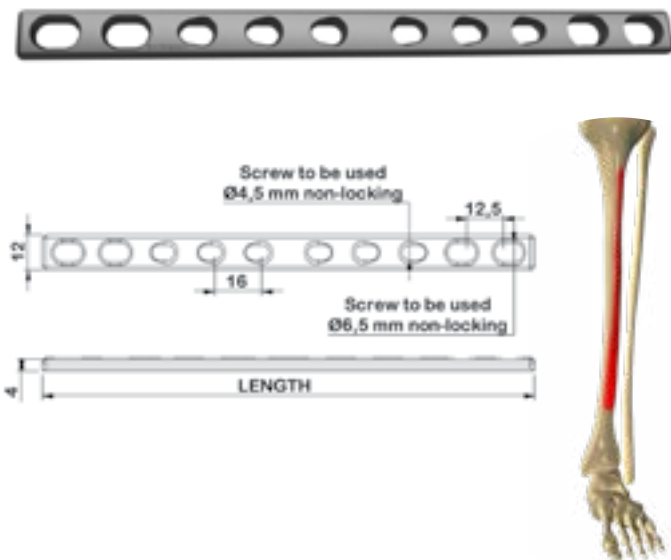

Screw to be used	Thickness (mm)	Width (mm)	
Ø (4,5 / 6,5 mm)	4,0	12,0	
SS	Ti	HOLES	LENGTH (mm)
O100 02 151 0002	O110 02 151 0002	2	39
O100 02 151 0003	O110 02 151 0003	3	55
O100 02 151 0004	O110 02 151 0004	4	71
O100 02 151 0005	O110 02 151 0005	5	87
O100 02 151 0006	O110 02 151 0006	6	103
O100 02 151 0007	O110 02 151 0007	7	119
O100 02 151 0008	O110 02 151 0008	8	135
O100 02 151 0009	O110 02 151 0009	9	151
O100 02 151 0010	O110 02 151 0010	10	167
O100 02 151 0011	O110 02 151 0011	11	183
O100 02 151 0012	O110 02 151 0012	12	199
O100 02 151 0013	O110 02 151 0013	13	215
O100 02 151 0014	O110 02 151 0014	14	231
O100 02 151 0015	O110 02 151 0015	15	247
O100 02 151 0016	O110 02 151 0016	16	263

4,5 mm Straight Reconstruction Plate

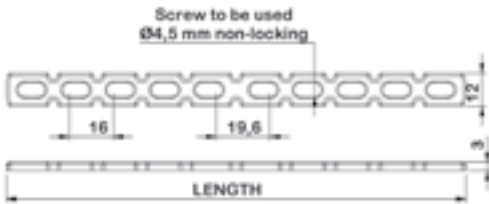

Screw to be used	Thickness (mm)	Width (mm)	
Ø (4,5 mm)	3,0	12,0	
SS	TI	HOLES	LENGTH (mm)
O100 02 277 0004	O110 02 277 0004	4	71
O100 02 277 0005	O110 02 277 0005	5	87
O100 02 277 0006	O110 02 277 0006	6	103
O100 02 277 0007	O110 02 277 0007	7	119
O100 02 277 0008	O110 02 277 0008	8	135
O100 02 277 0009	O110 02 277 0009	9	151
O100 02 277 0010	O110 02 277 0010	10	167
O100 02 227 0011	O110 02 227 0011	11	183
O100 02 227 0012	O110 02 227 0012	12	199
O100 02 227 0013	O110 02 227 0013	13	215
O100 02 227 0014	O110 02 227 0014	14	231
O100 02 227 0015	O110 02 227 0015	15	247
O100 02 227 0016	O110 02 227 0016	16	263

4,5 mm Curved Reconstruction Plate

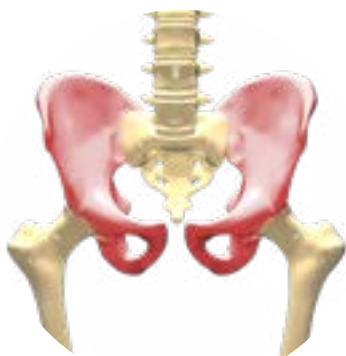
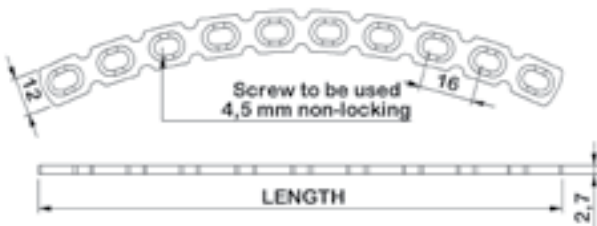

Screw to be used	Thickness (mm)	Width (mm)	
Ø (4,5 mm)	2,7	12,0	
SS	TI	HOLES	LENGTH (mm)
O100 02 228 0004	O110 02 228 0004	4	61,4
O100 02 228 0005	O110 02 228 0005	5	77,3
O100 02 228 0006	O110 02 228 0006	6	93,2
O100 02 228 0007	O110 02 228 0007	7	108,9
O100 02 228 0008	O110 02 228 0008	8	124,7
O100 02 228 0009	O110 02 228 0009	9	139,8
O100 02 228 0010	O110 02 228 0010	10	154,9
O100 02 228 0011	O110 02 228 0011	11	169,6
O100 02 228 0012	O110 02 228 0012	12	184
O100 02 228 0013	O110 02 228 0013	13	198
O100 02 228 0014	O110 02 228 0014	14	211,6
O100 02 228 0015	O110 02 228 0015	15	224,7
O100 02 228 0016	O110 02 228 0016	16	237,5

4,5 mm Semi Tubular

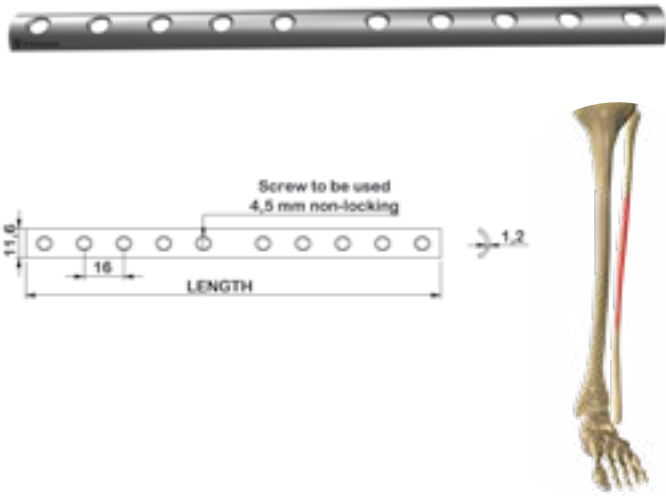

Screw to be used	Thickness (mm)	Width (mm)	
Ø (4,5 mm)	1,2	11,6	
SS	TI	HOLES	LENGTH (mm)
O100 02 180 0004	O110 02 180 0004	4	71
O100 02 180 0005	O110 02 180 0005	5	87
O100 02 180 0006	O110 02 180 0006	6	103
O100 02 180 0007	O110 02 180 0007	7	119
O100 02 180 0008	O110 02 180 0008	8	135
O100 02 180 0009	O110 02 180 0009	9	151
O100 02 180 0010	O110 02 180 0010	10	167
O100 02 180 0011	O110 02 180 0011	11	183
O100 02 180 0012	O110 02 180 0012	12	231

4,5 mm Spoon Plate

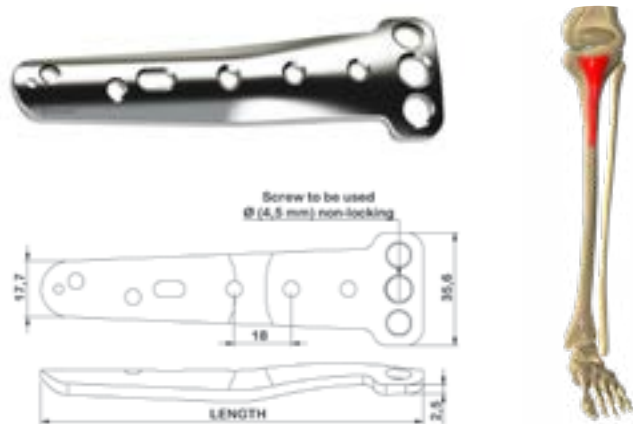

Screw to be used	Thickness (mm)	Width (mm)
Ø (4,5mm)	2,5	17,7 - 35,6
SS	HOLES	LENGTH (mm)
O100 02 260 0005	5	101,4
O100 02 260 0006	6	120,6

4,5 / 6,5 mm Cobra Head Plate

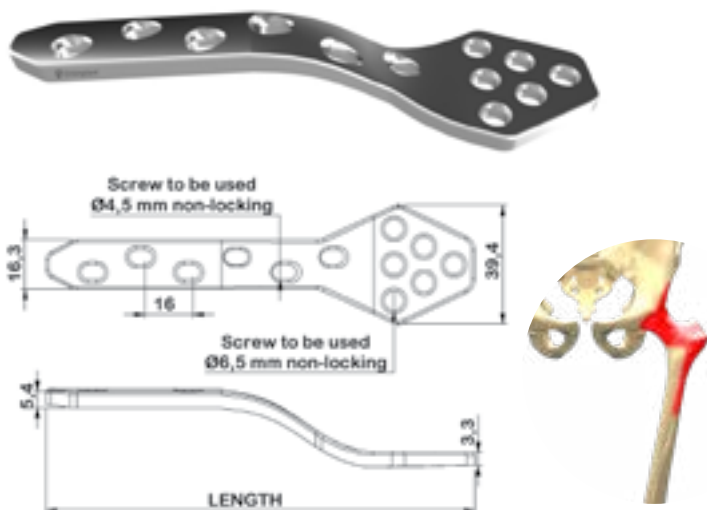

Screw to be used	Thickness (mm)	Width (mm)
Ø (4,5 / 6,5 mm)	5,4	16,3 - 39,4
SS	HOLES	LENGTH (mm)
O200 02 180 0006	6	143
O200 02 180 0007	7	159
O200 02 180 0008	8	175
O200 02 180 0009	9	191
O200 02 180 0010	10	207
O200 02 180 0011	11	223
O200 02 180 0012	12	239
O200 02 180 0013	13	255

4,5 / 6,5 mm T - Buttress Plate

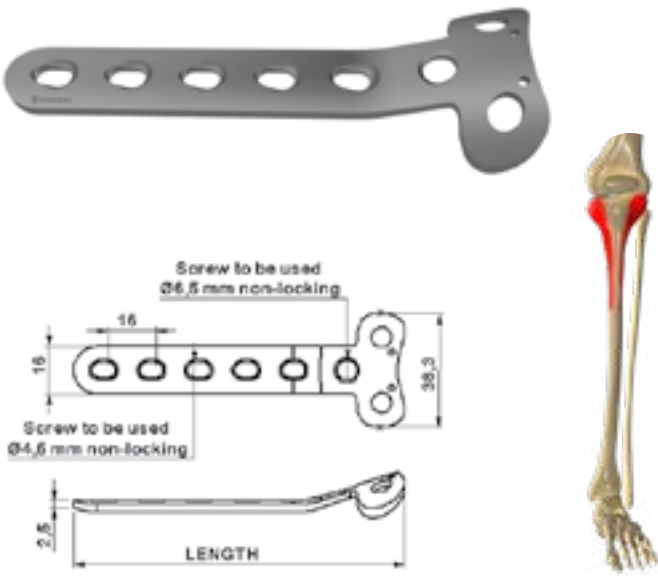

Screw to be used	Thickness (mm)	Width (mm)	
Ø (4,5 / 6,5 mm)	2,5	16 - 38,3	
SS	TI	HOLES	LENGTH (mm)
O101 02 190 0003	O111 02 190 0003	3	63,5
O101 02 190 0004	O111 02 190 0004	4	79,5
O101 02 190 0005	O111 02 190 0005	5	95,5
O101 02 190 0006	O111 02 190 0006	6	111,5
O101 02 190 0007	O111 02 190 0007	7	127,5
O101 02 190 0008	O111 02 190 0008	8	143,5

4,5 / 6,5 mm L - Buttress Plate

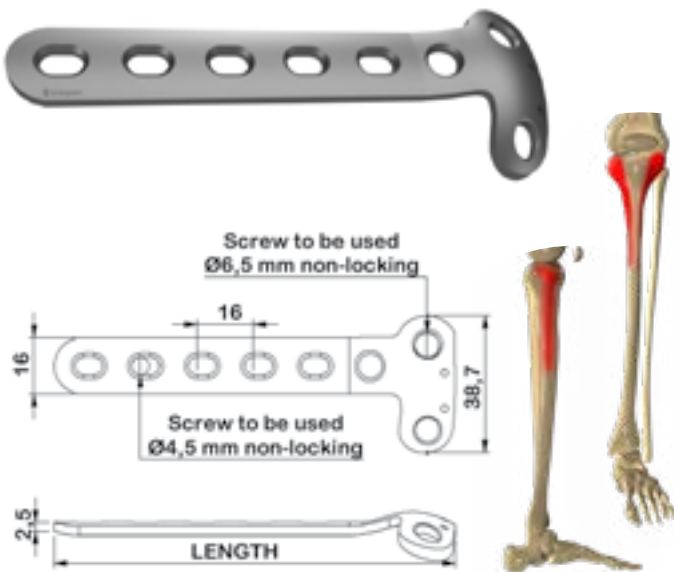

Screw to be used	Thickness (mm)	Width (mm)		
Ø (4,5 / 6,5 mm)	2,5	16 - 38,7		
SS	TI	HOLES	SIDE	LENGTH (mm)
O100 02 203 0003	O110 02 203 0003	3	Left	65,1
O100 02 203 0004	O110 02 203 0004	4	Left	81,1
O100 02 203 0005	O110 02 203 0005	5	Left	97,1
O100 02 203 0006	O110 02 203 0006	6	Left	113,1
O100 02 203 0007	O110 02 203 0007	7	Left	129,1
O100 02 203 0008	O110 02 203 0008	8	Left	145,1
O100 02 204 0003	O110 02 204 0003	3	Right	65,1
O100 02 204 0004	O110 02 204 0004	4	Right	81,1
O100 02 204 0005	O110 02 204 0005	5	Right	97,1
O100 02 204 0006	O110 02 204 0006	6	Right	113,1
O100 02 204 0007	O110 02 204 0007	7	Right	129,1
O100 02 204 0008	O110 02 204 0008	8	Right	145,1



4,5 mm Proximal Lateral Tibia Plate

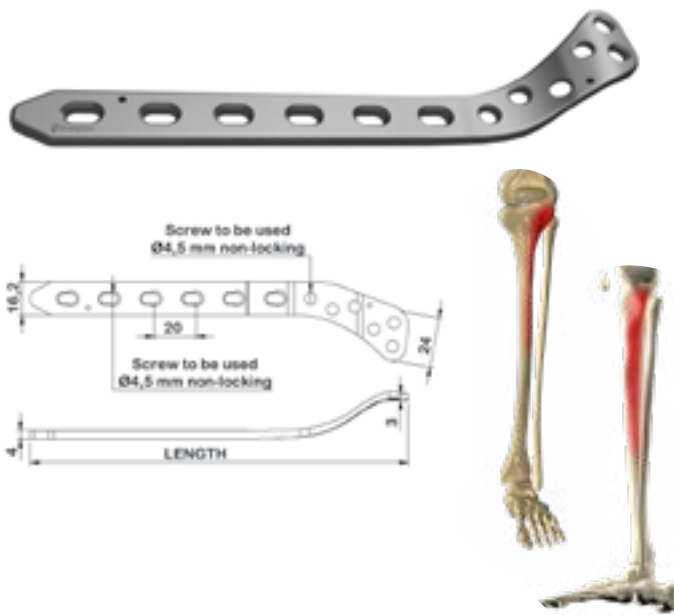

Screw to be used	Thickness (mm)	Width (mm)		
Ø (4,5 mm)	4,0	16,2 - 24		
SS	TI	HOLES	SIDE	LENGTH (mm)
O100 02 256 0005	O110 02 256 0005	5	Left	141,8
O100 02 256 0007	O110 02 256 0007	7	Left	181,8
O100 02 256 0009	O110 02 256 0009	9	Left	221,8
O100 02 256 0011	O110 02 256 0011	11	Left	261,8
O100 02 256 0013	O110 02 256 0013	13	Left	301,8
O100 02 257 0005	O110 02 257 0005	5	Right	141,8
O100 02 257 0007	O110 02 257 0007	7	Right	181,8
O100 02 257 0009	O110 02 257 0009	9	Right	221,8
O100 02 257 0011	O110 02 257 0011	11	Right	261,8
O100 02 257 0013	O110 02 257 0013	13	Right	301,8

4,5 mm Distal Tibia Lateral Plate

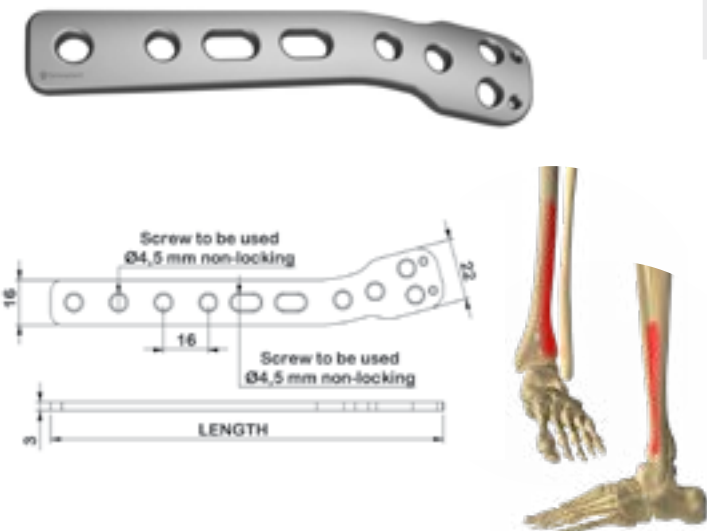

Screw to be used	Thickness (mm)	Width (mm)		
Ø (4,5 mm)	3,0	16 - 22		
SS	TI	HOLES	SIDE	LENGTH (mm)
O100 02 240 0005	O110 02 240 0005	5	Left	108,3
O100 02 240 0007	O110 02 240 0007	7	Left	140,3
O100 02 240 0009	O110 02 240 0009	9	Left	172,3
O100 02 240 0011	O110 02 240 0011	11	Left	204,3
O100 02 240 0013	O110 02 240 0013	13	Left	236,3
O100 02 241 0005	O110 02 241 0005	5	Right	108,3
O100 02 241 0007	O110 02 241 0007	7	Right	140,3
O100 02 241 0009	O110 02 241 0009	9	Right	172,3
O100 02 241 0011	O110 02 241 0011	11	Right	204,3
O100 02 241 0013	O110 02 241 0013	13	Right	236,3

3,5 mm Distal Tibia Medial Plate 2

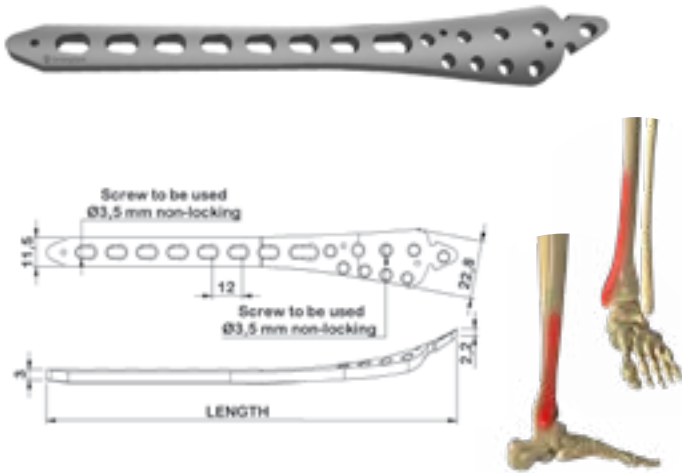

Screw to be used		Thickness (mm)	Width (mm)		
Ø (3,5 mm)		3,0	11,5 - 22,8		
SS	TI	HOLES	SIDE	LENGTH (mm)	
O100 02 242 0005	O110 02 242 0005	5	Left	125,9	
O100 02 242 0007	O110 02 242 0007	7	Left	149,9	
O100 02 242 0009	O110 02 242 0009	9	Left	173,9	
O100 02 242 0011	O110 02 242 0011	11	Left	197,9	
O100 02 242 0013	O110 02 242 0013	13	Left	221,9	
O100 02 243 0005	O110 02 243 0005	5	Right	125,9	
O100 02 243 0007	O110 02 243 0007	7	Right	149,9	
O100 02 243 0009	O110 02 243 0009	9	Right	173,9	
O100 02 243 0011	O110 02 243 0011	11	Right	197,9	
O100 02 243 0013	O110 02 243 0013	13	Right	221,9	

3,5 mm Distal Fibula Plate 1

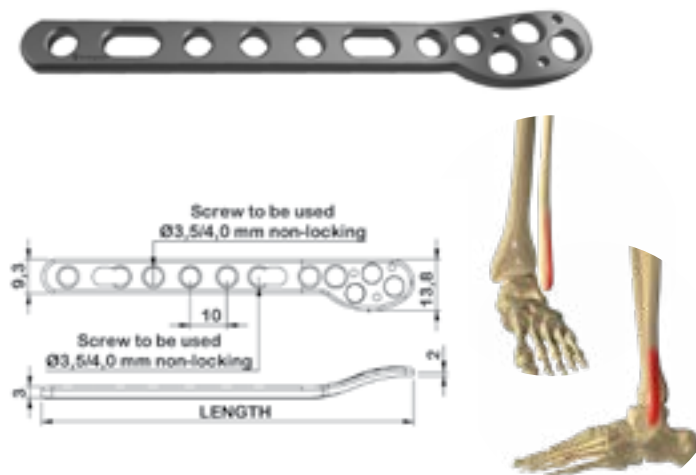

Screw to be used		Thickness (mm)	Width (mm)		
Ø (3,5 / 4,0 mm)		3,0	9,3 - 13,8		
SS	TI	HOLES	SIDE	LENGTH (mm)	
O5099102	O5098102	2	Left	61	
O5099104	O5098104	4	Left	81	
O5099105	O5098105	5	Left	91	
O5099106	O5098106	6	Left	101	
O5099107	O5098107	7	Left	111	
O5099108	O5098108	8	Left	121	
O5099109	O5098109	9	Left	131	
O5099110	O5098110	10	Left	141	
O5099202	O5098202	2	Right	61	
O5099204	O5098204	4	Right	81	
O5099205	O5098205	5	Right	91	
O5099206	O5098206	6	Right	101	
O5099207	O5098207	7	Right	111	
O5099208	O5098208	8	Right	121	
O5099209	O5098209	9	Right	131	
O5099210	O5098210	10	Right	141	



# LARGE FRAGMENT NON LOCKING SCREWS

---

product  
group



## 4,5 mm Self - Tapping Cortical Screw



SS	TI	DIA. x LENGTH (mm)	SS	TI	DIA. x LENGTH (mm)
O100 03 223 0140	O110 03 223 0140	4,5X14	O100 03 223 0400	O110 03 223 0400	4,5X40
O100 03 223 0160	O110 03 223 0160	4,5X16	O100 03 223 0420	O110 03 223 0420	4,5X42
O100 03 223 0180	O110 03 223 0180	4,5X18	O100 03 223 0440	O110 03 223 0440	4,5X44
O100 03 223 0200	O110 03 223 0200	4,5X20	O100 03 223 0460	O110 03 223 0460	4,5X46
O100 03 223 0220	O110 03 223 0220	4,5X22	O100 03 223 0480	O110 03 223 0480	4,5X48
O100 03 223 0240	O110 03 223 0240	4,5X24	O100 03 223 0500	O110 03 223 0500	4,5X50
O100 03 223 0260	O110 03 223 0260	4,5X26	O100 03 223 0520	O110 03 223 0520	4,5X52
O100 03 223 0280	O110 03 223 0280	4,5X28	O100 03 223 0540	O110 03 223 0540	4,5X54
O100 03 223 0300	O110 03 223 0300	4,5X30	O100 03 223 0560	O110 03 223 0560	4,5X56
O100 03 223 0320	O110 03 223 0320	4,5X32	O100 03 223 0580	O110 03 223 0580	4,5X58
O100 03 223 0340	O110 03 223 0340	4,5X34	O100 03 223 0600	O110 03 223 0600	4,5X60
O100 03 223 0360	O110 03 223 0360	4,5X36	O100 03 223 0650	O110 03 223 0650	4,5X65
O100 03 223 0380	O110 03 223 0380	4,5X38	O100 03 223 0700	O110 03 223 0700	4,5X70

## 6,5 mm Cancellous Screw 16 mm Threaded



SS	TI	DIA. x LENGTH (mm)	SS	TI	DIA. x LENGTH (mm)
O100 03 225 0500	O110 03 225 0500	6,5X50	O100 03 225 0850	O110 03 225 0850	6,5X85
O100 03 225 0550	O110 03 225 0550	6,5X55	O100 03 225 0900	O110 03 225 0900	6,5X90
O100 03 225 0600	O110 03 225 0600	6,5X60	O100 03 225 0950	O110 03 225 0950	6,5X95
O100 03 225 0650	O110 03 225 0650	6,5X65	O100 03 225 1000	O110 03 225 1000	6,5X100
O100 03 225 0700	O110 03 225 0700	6,5X70	O100 03 225 1050	O110 03 225 1050	6,5X105
O100 03 225 0750	O110 03 225 0750	6,5X75	O100 03 225 1100	O110 03 225 1100	6,5X110
O100 03 225 0800	O110 03 225 0800	6,5X80			

## 6,5 mm Cancellous Screw 32 mm Threaded



SS	TI	DIA. x LENGTH (mm)	SS	TI	DIA. x LENGTH (mm)
O100 03 226 0500	O110 03 226 0500	6,5X50	O100 03 226 0850	O110 03 226 0850	6,5X85
O100 03 226 0550	O110 03 226 0550	6,5X55	O100 03 226 0900	O110 03 226 0900	6,5X90
O100 03 226 0600	O110 03 226 0600	6,5X60	O100 03 226 0950	O110 03 226 0950	6,5X95
O100 03 226 0650	O110 03 226 0650	6,5X65	O100 03 226 1000	O110 03 226 1000	6,5X100
O100 03 226 0700	O110 03 226 0700	6,5X70	O100 03 226 1050	O110 03 226 1050	6,5X105
O100 03 226 0750	O110 03 226 0750	6,5X75	O100 03 226 1100	O110 03 226 1100	6,5X110
O100 03 226 0800	O110 03 226 0800	6,5X80			

6,5 mm Cancellous Screw Full Threaded

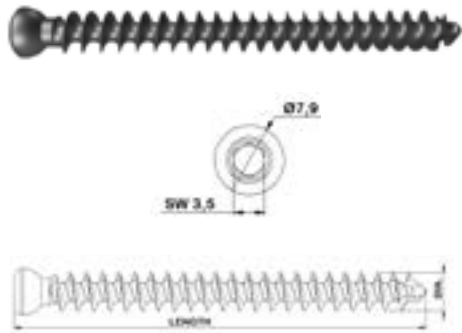

SS	TI	DIA. x LENGTH (mm)
O100 03 227 0500	O110 03 227 0500	6,5X50
O100 03 227 0550	O110 03 227 0550	6,5X55
O100 03 227 0600	O110 03 227 0600	6,5X60
O100 03 227 0650	O110 03 227 0650	6,5X65
O100 03 227 0700	O110 03 227 0700	6,5X70
O100 03 227 0750	O110 03 227 0750	6,5X75
O100 03 227 0800	O110 03 227 0800	6,5X80
O100 03 227 0850	O110 03 227 0850	6,5X85
O100 03 227 0900	O110 03 227 0900	6,5X90
O100 03 227 0950	O110 03 227 0950	6,5X95
O100 03 227 1000	O110 03 227 1000	6,5X100
O100 03 227 1050	O110 03 227 1050	6,5X105
O100 03 227 1100	O110 03 227 1100	6,5X110

4,5 mm Malleolar Screw



SS	TI	DIA. x LENGTH (mm)
O100 03 224 0250	O110 03 224 0250	4,5X25
O100 03 224 0300	O110 03 224 0300	4,5X30
O100 03 224 0350	O110 03 224 0350	4,5X35
O100 03 224 0400	O110 03 224 0400	4,5X40
O100 03 224 0450	O110 03 224 0450	4,5X45
O100 03 224 0500	O110 03 224 0500	4,5X50
O100 03 224 0550	O110 03 224 0550	4,5X55
O100 03 224 0600	O110 03 224 0600	4,5X60
O100 03 224 0650	O110 03 224 0650	4,5X65
O100 03 224 0700	O110 03 224 0700	4,5X70

Washer

SS	DIA(mm)
O110 04 000 0014	13

SS	DIA(mm)
O110 04 000 0010	10

SS	TI	DIA. (mm)
O34004108	O34004008	8



Screw to be used  
Ø6,5/7,3 mm non-locking



Screw to be used  
Ø4,5 mm non-locking

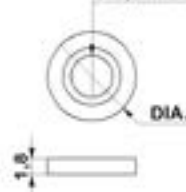

Screw to be used  
Ø3,5-4,0 mm non-locking



\* DIA. Means DIAMETER



# DHS - DCS PLATES

---

product  
group



DHS Locking Plate 135°

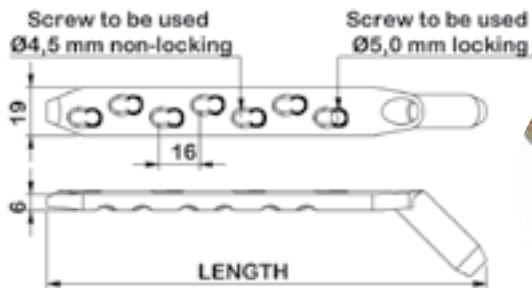

Screw to be used	Thickness (mm)		Width (mm)	
Ø (4,5 / 5,0 mm)	6,0		19,0	
SS	TI	HOLES	LENGTH (mm)	
O5839102	O5838102	2	91,3	
O5839103	O5838103	3	107,3	
O5839104	O5838104	4	123,3	
O5839105	O5838105	5	139,3	
O5839106	O5838106	6	153,3	
O5839107	O5838107	7	171,3	
O5839108	O5838108	8	187,3	
O5839109	O5838109	9	203,3	
O5839110	O5838110	10	219,3	
O5839111	O5838111	11	235,3	
O5839112	O5838112	12	251,3	

DCS Locking Plate 95°

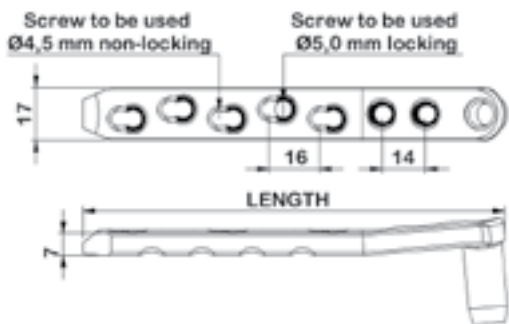

Screw to be used	Thickness (mm)		Width (mm)	
Ø (4,5 / 5,0 mm)	7,0		17,0	
SS	TI	HOLES	LENGTH (mm)	
O5829102	O5828102	2	86,8	
O5829103	O5828103	3	102,8	
O5829104	O5828104	4	118,8	
O5829105	O5828105	5	134,8	
O5829106	O5828106	6	150,8	
O5829107	O5828107	7	166,8	
O5829108	O5828108	8	182,8	
O5829109	O5828109	9	198,8	
O5829110	O5828110	10	214,8	
O5829111	O5828111	11	230,8	
O5829112	O5828112	12	246,8	

DHS Plate 135°

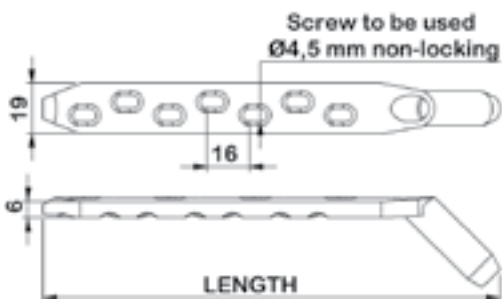

Screw to be used	Thickness (mm)		Width (mm)	
Ø (4,5 mm)	6,0		19,0	
SS	TI	HOLES	LENGTH (mm)	
O100 02 310 0002	O110 02 310 0002	2	91,4	
O100 02 310 0003	O110 02 310 0003	3	107,4	
O100 02 310 0004	O110 02 310 0004	4	123,4	
O100 02 310 0005	O110 02 310 0005	5	139,4	
O100 02 310 0006	O110 02 310 0006	6	155,4	
O100 02 310 0007	O110 02 310 0007	7	171,4	
O100 02 310 0008	O110 02 310 0008	8	187,4	
O100 02 310 0009	O110 02 310 0009	9	203,4	
O100 02 310 0010	O110 02 310 0010	10	219,4	
O100 02 310 0011	O110 02 310 0011	11	235,4	
O100 02 310 0012	O110 02 310 0012	12	251,4	

DCS Plate 95°

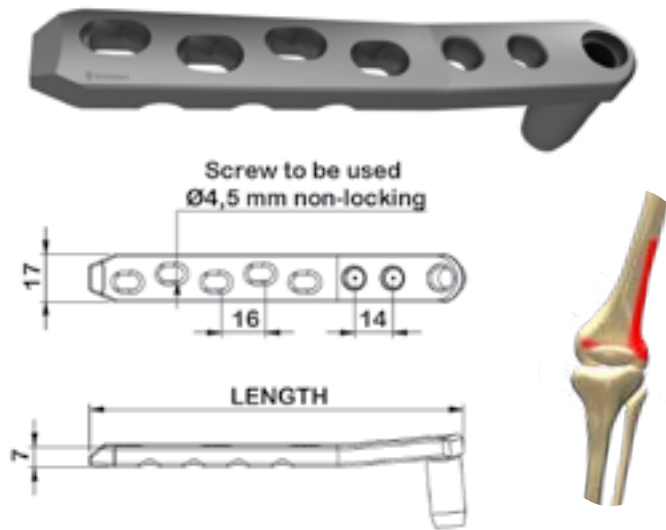

Screw to be used	Thickness (mm)	Width (mm)	
Ø (4,5 mm)	7,0	17,0	
SS	TI	HOLES	LENGTH (mm)
O100 02 314 0002	O110 02 314 0002	2	86,7
O100 02 314 0003	O110 02 314 0003	3	102,7
O100 02 314 0004	O110 02 314 0004	4	118,7
O100 02 314 0005	O110 02 314 0005	5	134,7
O100 02 314 0006	O110 02 314 0006	6	150,7
O100 02 314 0007	O110 02 314 0007	7	166,7
O100 02 314 0008	O110 02 314 0008	8	182,7
O100 02 314 0009	O110 02 314 0009	9	198,7
O100 02 314 0010	O110 02 314 0010	10	214,7
O100 02 314 0011	O110 02 314 0011	11	230,7
O100 02 314 0012	O110 02 314 0012	12	246,7

DHS / DCS Lag Screw

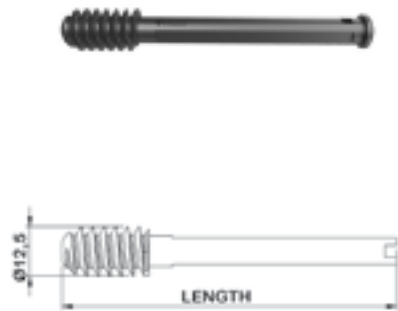

SS	TI	LENGTH (mm)
O100 03 011 0500	O110 03 011 0500	50
O100 03 011 0550	O110 03 011 0550	55
O100 03 011 0600	O110 03 011 0600	60
O100 03 011 0650	O110 03 011 0650	65
O100 03 011 0700	O110 03 011 0700	70
O100 03 011 0750	O110 03 011 0750	75
O100 03 011 0800	O110 03 011 0800	80
O100 03 011 0850	O110 03 011 0850	85
O100 03 011 0900	O110 03 011 0900	90
O100 03 011 1950	O100 03 011 1950	95
O100 03 011 1000	O100 03 011 1000	100
O100 03 011 1050	O100 03 011 1050	105
O100 03 011 1100	O100 03 011 1100	110
O100 03 011 1150	O100 03 011 1150	115
O100 03 011 1200	O100 03 011 1200	120
O100 03 011 1250	O100 03 011 1250	125

DHS / DCS Lag Screw

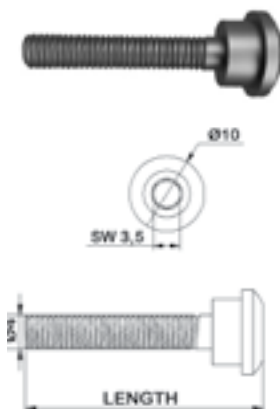

SS	TI	LENGTH (mm)
O100 03 011 1051	O5878050	28



# ANGLED PLATES

---

product  
group

4,5 mm 135° Angled Blade Plate for operation on adult femur

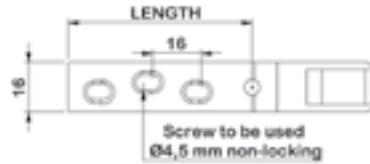
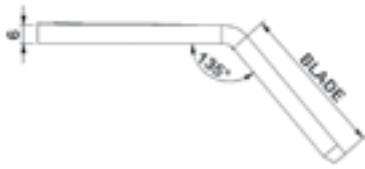

Screw to be used  
Ø4,5 mm non-locking

Screw to be used		Thickness (mm)		Width (mm)			
Ø (4,5 mm)		6,0		16,0			
SS	HOLES	BLADE (mm)	LENGTH (mm)	SS	HOLES	BLADE (mm)	LENGTH (mm)
O100 02 040 4050	4	50	76	O100 02 140 1280	7	80	124
O100 02 040 4060	4	60	76	O100 02 140 1290	7	90	124
O100 02 040 4070	4	70	76	O100 02 140 1200	7	100	124
O100 02 040 4080	4	80	76	O100 02 141 9050	8	50	140
O100 02 040 4090	4	90	76	O100 02 141 9060	8	60	140
O100 02 040 4100	4	100	76	O100 02 141 9070	8	70	140
O100 02 041 4050	5	50	92	O100 02 141 9080	8	80	140
O100 02 041 4060	5	60	92	O100 02 141 9090	8	90	140
O100 02 041 4070	5	70	92	O100 02 141 9100	8	100	140
O100 02 041 4080	5	80	92	O100 02 041 9050	9	50	156
O100 02 041 4090	5	90	92	O100 02 041 9060	9	60	156
O100 02 041 4100	5	100	92	O100 02 041 9070	9	70	156
O100 02 040 1250	6	50	108	O100 02 041 9080	9	80	156
O100 02 040 1260	6	60	108	O100 02 041 9090	9	90	156
O100 02 040 1270	6	70	108	O100 02 041 9100	9	100	156
O100 02 040 1280	6	80	108	O100 02 041 1250	12	50	204
O100 02 040 1290	6	90	108	O100 02 041 1260	12	60	204
O100 02 040 1200	6	100	108	O100 02 041 1270	12	70	204
O100 02 140 1250	7	50	124	O100 02 041 1280	12	80	204
O100 02 140 1260	7	60	124	O100 02 041 1290	12	90	204
O100 02 140 1270	7	70	124	O100 02 041 1200	12	100	204

4,5 mm 95° Angled Blade Plate for operation on adult femur

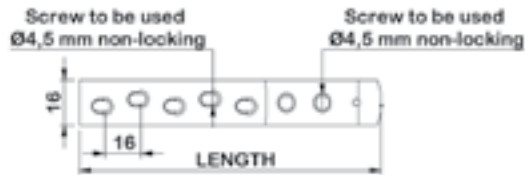

Screw to be used		Thickness (mm)		Width (mm)			
Ø (4,5 mm)		6,0		20,0			
SS	HOLES	BLADE (mm)	LENGTH (mm)	SS	HOLES	BLADE (mm)	LENGTH (mm)
O100 02 140 4050	4	50	86	O100 02 140 6080	7	80	134
O100 02 140 4060	4	60	86	O100 02 140 7065	7	90	134
O100 02 140 4070	4	70	86	O100 02 140 7085	7	100	134
O100 02 140 4080	4	80	86	O100 02 140 8050	8	50	150
O100 02 140 4090	4	90	86	O100 02 140 8060	8	60	150
O100 02 140 4100	4	100	86	O100 02 140 8070	8	70	150
O100 02 141 4050	5	50	102	O100 02 140 8080	8	80	150
O100 02 141 4060	5	60	102	O100 02 141 6090	8	90	150
O100 02 141 4070	5	70	102	O100 02 141 6100	8	100	150
O100 02 141 4080	5	80	102	O100 02 140 9050	9	50	166
O100 02 141 4090	5	90	102	O100 02 140 9060	9	60	166
O100 02 141 4100	5	100	102	O100 02 140 9070	9	70	166
O100 02 140 6051	6	50	118	O100 02 140 9080	9	80	166
O100 02 140 6061	6	60	118	O100 02 140 9090	9	90	166
O100 02 140 6071	6	70	118	O100 02 140 9100	9	100	166
O100 02 140 6081	6	80	118	O100 02 141 1250	12	50	214
O100 02 140 6090	6	90	118	O100 02 141 1260	12	60	214
O100 02 140 6100	6	100	118	O100 02 141 1270	12	70	214
O100 02 140 6050	7	50	134	O100 02 141 1280	12	80	214
O100 02 140 6060	7	60	134	O100 02 141 1290	12	90	214
O100 02 140 6070	7	70	134	O100 02 141 1200	12	100	214

4,5 mm 90° Angled Blade Plate with displacement for operation on adolescent femur

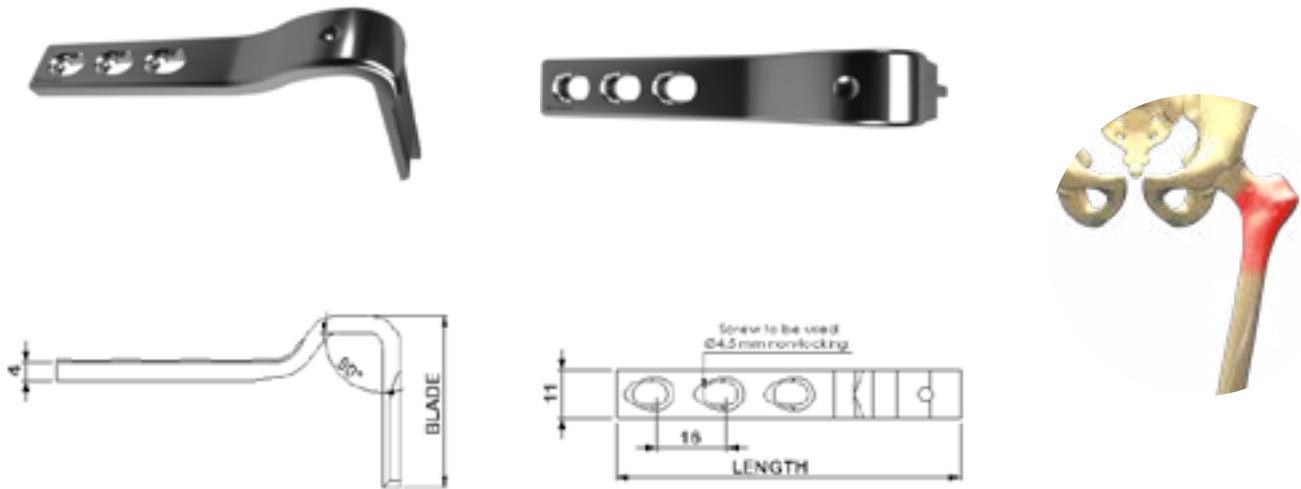

Screw to be used	Thickness (mm)	Width (mm)	
Ø (4,5 mm)	4,0	11,0	
SS	HOLES	BLADE (mm)	LENGTH (mm)
O100 02 070 1040	3	40	78,5
O100 02 070 1045	3	45	78,5
O100 02 070 1050	3	50	78,5
O100 02 070 1055	3	55	78,5
O100 02 070 1060	3	60	78,5

3,5 mm 90° Angled Blade Plate with displacement for operation on pediatric femur

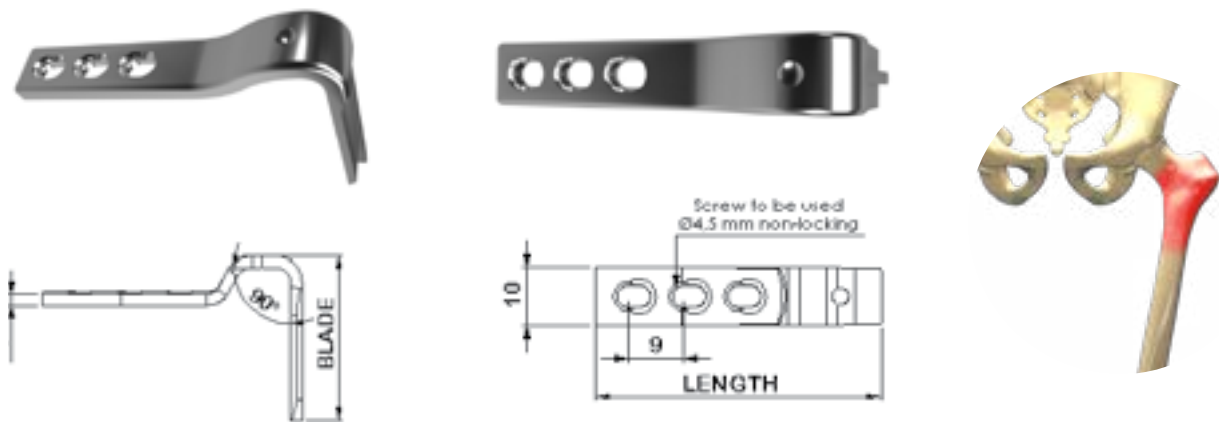

Screw to be used	Thickness (mm)	Width (mm)	
Ø (3,5 mm)	2,5	10,0	
SS	HOLES	BLADE (mm)	LENGTH (mm)
O100 02 050 1225	3	25	51,7
O100 02 050 1230	3	30	51,7
O100 02 050 1232	3	32	51,7
O100 02 050 1235	3	35	51,7

3,5 mm Mini Pediatric Locking Plate 100°

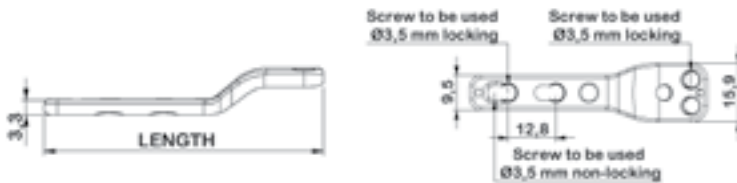

Screw to be used	Thickness (mm)	Width (mm)	
Ø (3,5 mm)	3,3	9,5 - 15,9	
SS	TI	HOLES	LENGTH (mm)
O100 02 051 0725	O100 02 051 0730	3	64



3,5 mm Pediatric Locking Plate 100°



Screw to be used	Thickness (mm)	Width (mm)	
Ø (3,5 mm)	3,4	12,4 - 19,2	
SS	TI	HOLES	LENGTH (mm)
O100 02 051 0732	O100 02 051 0735	3	76



3,5 mm Pediatric Locking Plate 110°

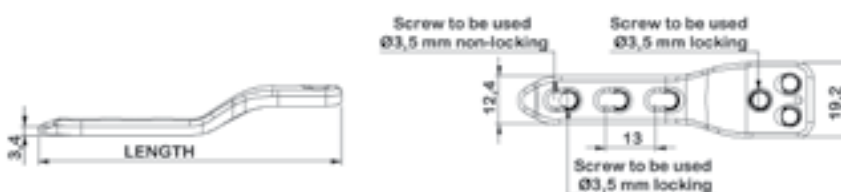

Screw to be used	Thickness (mm)	Width (mm)	
Ø (3,5 mm)	3,4	12,4 - 19,2	
SS	TI	HOLES	LENGTH (mm)
O100 02 051 1232	O100 02 051 1235	3	76



3,5 mm Pediatric Locking Plate 150°

Screw to be used	Thickness (mm)	Width (mm)	
Ø (3,5 mm)	3,4	12,8 - 19,4	
SS	TI	HOLES	LENGTH (mm)
O100 02 050 0725	O100 02 050 0730	3	65

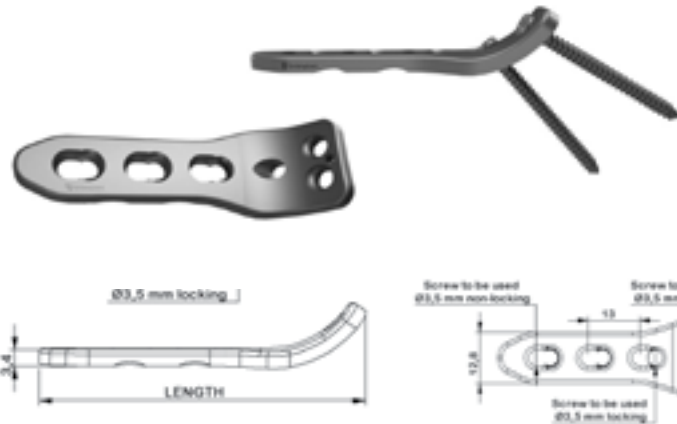

Pediatric Eight Plate (for epiphysiodesis)

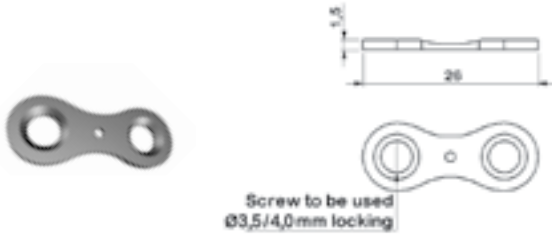

TI  
O100 02 050 0732

TYPE  
SMALL

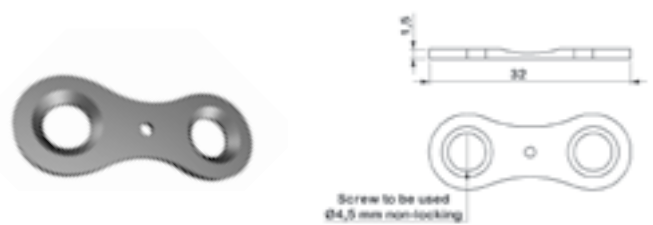

TI  
O100 02 050 0735

TYPE  
LARGE



# CANNULATED SCREWS

---

product  
group



2,7 mm Cannulated Screw Partially Threaded

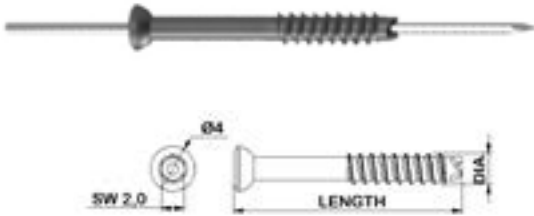

TI	DIA. x LENGTH (mm)
O6072718	2,7X18
O6072720	2,7X20
O6072722	2,7X22
O6072724	2,7X24
O6072726	2,7X26
O6072728	2,7X28
O6072730	2,7X30

3,5 mm Cannulated Screw Partially Threaded



TI	DIA. x LENGTH (mm)
O6073516	3,5X16
O6073518	3,5X18
O6073520	3,5X20
O6073522	3,5X22
O6073524	3,5X24
O6073526	3,5X26
O6073528	3,5X28
O6073530	3,5X30
O6073532	3,5X32

TI	DIA. x LENGTH (mm)
O6073534	3,5X34
O6073536	3,5X36
O6073538	3,5X38
O6073540	3,5X40
O6073542	3,5X42
O6073544	3,5X44
O6073546	3,5X46
O6073548	3,5X48
O6073550	3,5X50

3,5 mm Cannulated Screw Full Threaded



TI	DIA. x LENGTH (mm)
O6083514	3,5X14
O6083516	3,5X16
O6083518	3,5X18
O6083520	3,5X20
O6083522	3,5X22
O6083524	3,5X24
O6083526	3,5X26
O6083528	3,5X28
O6083530	3,5X30
O6083532	3,5X32

TI	DIA. x LENGTH (mm)
O6083534	3,5X34
O6083536	3,5X36
O6083538	3,5X38
O6083540	3,5X40
O6083542	3,5X42
O6083544	3,5X44
O6083546	3,5X46
O6083548	3,5X48
O6083550	3,5X50



4,0 mm Cannulated Screw Partially Threaded



TI	DIA. x LENGTH (mm)
O6074020	4,0X20
O6074022	4,0X22
O6074024	4,0X24
O6074026	4,0X26
O6074028	4,0X28
O6074030	4,0X30
O6074032	4,0X32
O6074034	4,0X34
O6074036	4,0X36
O6074038	4,0X38
O6074040	4,0X40
O6074042	4,0X42
O6074044	4,0X44

TI	DIA. x LENGTH (mm)
O6074046	4,0X46
O6074048	4,0X48
O6074050	4,0X50
O6074052	4,0X52
O6074054	4,0X54
O6074056	4,0X56
O6074058	4,0X58
O6074060	4,0X60
O6074062	4,0X62
O6074064	4,0X64
O6074066	4,0X66
O6074068	4,0X68
O6074070	4,0X70

4,0 mm Cannulated Screw Full Threaded



TI	DIA. x LENGTH (mm)
O6084020	4,0X20
O6084022	4,0X22
O6084024	4,0X24
O6084026	4,0X26
O6084028	4,0X28
O6084030	4,0X30
O6084032	4,0X32
O6084034	4,0X34
O6084036	4,0X36
O6084038	4,0X38
O6084040	4,0X40
O6084042	4,0X42
O6084044	4,0X44

TI	DIA. x LENGTH (mm)
O6084046	4,0X46
O6084048	4,0X48
O6084050	4,0X50
O6084052	4,0X52
O6084054	4,0X54
O6084056	4,0X56
O6084058	4,0X58
O6084060	4,0X60
O6084062	4,0X62
O6084064	4,0X64
O6084066	4,0X66
O6084068	4,0X68
O6084070	4,0X70

\* DIA. Means DIAMETER

## 4,5 mm Cannulated Screw Partially Threaded



SS	TI	DIA. x LENGTH (mm)
O030120	O6074220	4,5X20
O030122	O6074222	4,5X22
O030124	O6074224	4,5X24
O030126	O6074226	4,5X26
O030128	O6074228	4,5X28
O030130	O6074230	4,5X30
O030132	O6074232	4,5X32
O030134	O6074234	4,5X34
O030136	O6074236	4,5X36
O030138	O6074238	4,5X38

SS	TI	DIA. x LENGTH (mm)
O030140	O6074240	4,5X40
O030142	O6074242	4,5X42
O030144	O6074244	4,5X44
O030146	O6074246	4,5X46
O030148	O6074248	4,5X48
O030150	O6074250	4,5X50
O030152	O6074252	4,5X52
O030154	O6074254	4,5X54
O030156	O6074256	4,5X56
O030158	O6074258	4,5X58
O030160	O6074260	4,5X60

## 4,5 mm Cannulated Screw Full Threaded



SS	TI	DIA. x LENGTH (mm)
O040120	O6074520	4,5X20
O040122	O6074522	4,5X22
O040124	O6074524	4,5X24
O040126	O6074526	4,5X26
O040128	O6074528	4,5X28
O040130	O6074530	4,5X30
O040132	O6074532	4,5X32
O040134	O6074534	4,5X34
O040136	O6074536	4,5X36
O040138	O6074538	4,5X38
O040140	O6074540	4,5X40

SS	TI	DIA. x LENGTH (mm)
O040142	O6074542	4,5X42
O040144	O6074544	4,5X44
O040146	O6074546	4,5X46
O040148	O6074548	4,5X48
O040150	O6074550	4,5X50
O040152	O6074552	4,5X52
O040154	O6074554	4,5X54
O040156	O6074556	4,5X56
O040158	O6074558	4,5X58
O040160	O6074560	4,5X60

## 6,5 mm Cannulated Screw 16 mm Threaded



SS	TI	DIA. x LENGTH (mm)	SS	TI	DIA. x LENGTH (mm)
O101 04 225 0300	O111 04 225 0300	6,5X30	O101 04 225 0800	O111 04 225 0800	6,5X80
O101 04 225 0350	O111 04 225 0350	6,5X35	O101 04 225 0850	O111 04 225 0850	6,5X85
O101 04 225 0400	O111 04 225 0400	6,5X40	O101 04 225 0900	O111 04 225 0900	6,5X90
O101 04 225 0450	O111 04 225 0450	6,5X45	O101 04 225 0950	O111 04 225 0950	6,5X95
O101 04 225 0500	O111 04 225 0500	6,5X50	O101 04 225 1000	O111 04 225 1000	6,5X100
O101 04 225 0550	O111 04 225 0550	6,5X55	O101 04 225 1050	O111 04 225 1050	6,5X105
O101 04 225 0600	O111 04 225 0600	6,5X60	O101 04 225 1100	O111 04 225 1100	6,5X110
O101 04 225 0650	O111 04 225 0650	6,5X65	O101 04 225 1150	O111 04 225 1150	6,5X115
O101 04 225 0700	O111 04 225 0700	6,5X70	O101 04 225 1200	O111 04 225 1200	6,5X120
O101 04 225 0750	O111 04 225 0750	6,5X75			

## 6,5 mm Cannulated Screw 32 mm Threaded



SS	TI	DIA. x LENGTH (mm)	SS	TI	DIA. x LENGTH (mm)
O101 04 300 0500	O111 04 300 0500	6,5X50	O101 04 300 0900	O111 04 300 0900	6,5X90
O101 04 300 0550	O111 04 300 0550	6,5X55	O101 04 300 0950	O111 04 300 0950	6,5X95
O101 04 300 0600	O111 04 300 0600	6,5X60	O101 04 300 1000	O111 04 300 1000	6,5X100
O101 04 300 0650	O111 04 300 0650	6,5X65	O101 04 300 1050	O111 04 300 1050	6,5X105
O101 04 300 0700	O111 04 300 0700	6,5X70	O101 04 300 1100	O111 04 300 1100	6,5X110
O101 04 300 0750	O111 04 300 0750	6,5X75	O101 04 300 1150	O111 04 300 1150	6,5X115
O101 04 300 0800	O111 04 300 0800	6,5X80	O101 04 300 1200	O111 04 300 1200	6,5X120
O101 04 300 0850	O111 04 300 0850	6,5X85			

## 6,5 mm Cannulated Screw Full Threaded

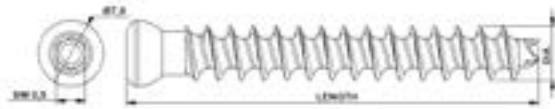

SS	TI	DIA. x LENGTH (mm)	SS	TI	DIA. x LENGTH (mm)
O101 04 330 0350	O111 04 330 0350	6,5X35	O101 04 330 0800	O111 04 330 0800	6,5X80
O101 04 330 0400	O111 04 330 0400	6,5X40	O101 04 330 0850	O111 04 330 0850	6,5X85
O101 04 330 0450	O111 04 330 0450	6,5X45	O101 04 330 0900	O111 04 330 0900	6,5X90
O101 04 330 0500	O111 04 330 0500	6,5X50	O101 04 330 0950	O111 04 330 0950	6,5X95
O101 04 330 0550	O111 04 330 0550	6,5X55	O101 04 330 1000	O111 04 330 1000	6,5X100
O101 04 330 0600	O111 04 330 0600	6,5X60	O101 04 330 1050	O111 04 330 1050	6,5X105
O101 04 330 0650	O111 04 330 0650	6,5X65	O101 04 330 1100	O111 04 330 1100	6,5X110
O101 04 330 0700	O111 04 330 0700	6,5X70	O101 04 330 1150	O111 04 330 1150	6,5X115
O101 04 330 0750	O111 04 330 0750	6,5X75	O101 04 330 1200	O111 04 330 1200	6,5X120

## 7,3 mm Cannulated Screw 16 mm Threaded



SS	TI	DIA. x LENGTH (mm)	SS	TI	DIA. x LENGTH (mm)
O6049050	O6048050	7,3X50	O6049090	O6048090	7,3X90
O6049055	O6048055	7,3X55	O6049095	O6048095	7,3X95
O6049060	O6048060	7,3X60	O6049100	O6048100	7,3X100
O6049065	O6048065	7,3X65	O6049105	O6048105	7,3X105
O6049070	O6048070	7,3X70	O6049110	O6048110	7,3X110
O6049075	O6048075	7,3X75	O6049115	O6048115	7,3X115
O6049080	O6048080	7,3X80	O6049120	O6048120	7,3X120
O6049085	O6048085	7,3X85			

7,3 mm Cannulated Screw 32 mm Threaded

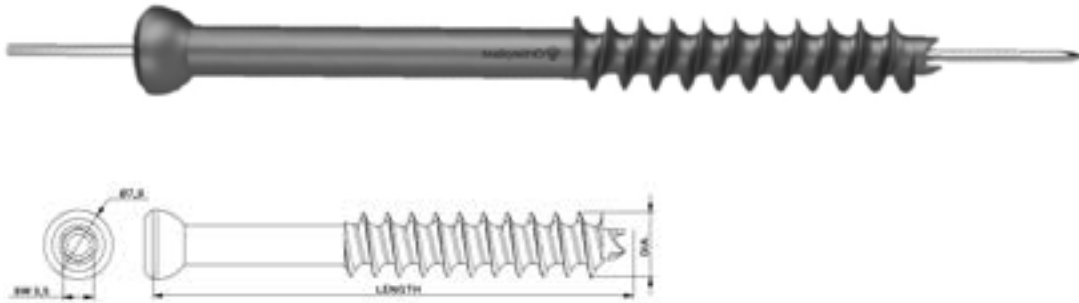

SS	TI	DIA. x LENGTH (mm)	SS	TI	DIA. x LENGTH (mm)
O6059050	O6058050	7,3X50	O6059090	O6058090	7,3X90
O6059055	O6058055	7,3X55	O6059095	O6058095	7,3X95
O6059060	O6058060	7,3X60	O6059100	O6058100	7,3X100
O6059065	O6058065	7,3X65	O6059105	O6058105	7,3X105
O6059070	O6058070	7,3X70	O6059110	O6058110	7,3X110
O6059075	O6058075	7,3X75	O6059115	O6058115	7,3X115
O6059080	O6058080	7,3X80	O6059120	O6058120	7,3X120
O6059085	O6058085	7,3X85			

Washer

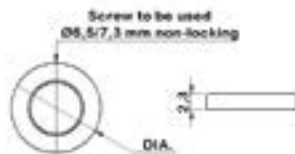

TI	DIA. (mm)
O110 04 000 0014	13

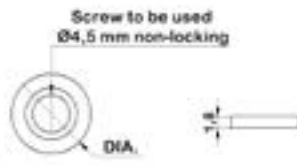

SS	DIA. (mm)
O110 04 000 0010	10

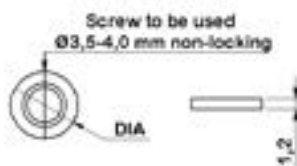

SS	TI	DIA. (mm)
O34004108	O34004008	8

\* DIA. Means DIAMETER



# HEADLESS SCREWS

---

product  
group



## 3,0 mm Headless Cannulated Compression Screw

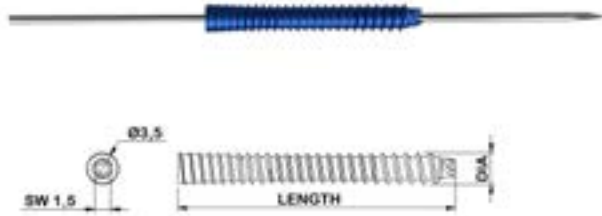

TI	DIA. x LENGTH (mm)
O6013014	3,0X14
O6013016	3,0X16
O6013018	3,0X18
O6013020	3,0X20
O6013022	3,0X22
O6013024	3,0X24
O6013026	3,0X26
O6013028	3,0X28
O6013030	3,0X30
O6013035	3,0X35
O6013040	3,0X40
O6013045	3,0X45
O6013050	3,0X50

## 3,5 mm Headless Cannulated Compression Screw

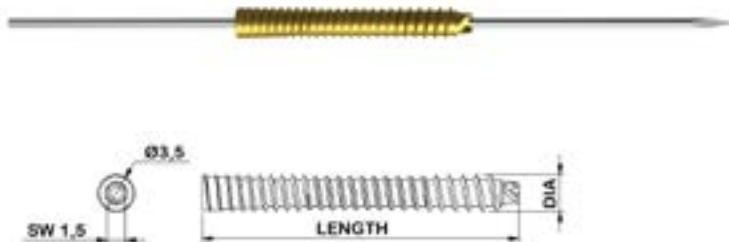

TI	DIA. x LENGTH (mm)
O6013514	3,5X14
O6013516	3,5X16
O6013518	3,5X18
O6013520	3,5X20
O6013522	3,5X22
O6013524	3,5X24
O6013526	3,5X26
O6013528	3,5X28
O6013530	3,5X30
O6013535	3,5X35
O6013540	3,5X40
O6013545	3,5X45
O6013550	3,5X50

## 4,0 mm Headless Cannulated Compression Screw

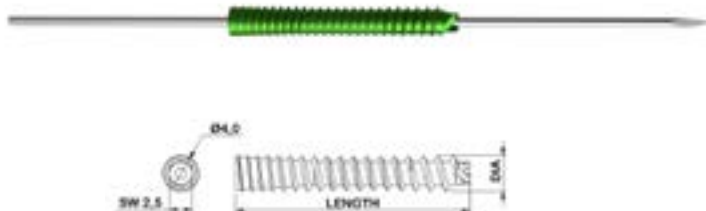

TI	DIA. x LENGTH (mm)
O6014015	4,0X15
O6014020	4,0X20
O6014025	4,0X25
O6014030	4,0X30
O6014035	4,0X35
O6014040	4,0X40
O6014045	4,0X45
O6014050	4,0X50
O6014055	4,0X55
O6014060	4,0X60
O6014065	4,0X65
O6014070	4,0X70
O6014075	4,0X75

5,0 mm Headless Cannulated Compression Screw

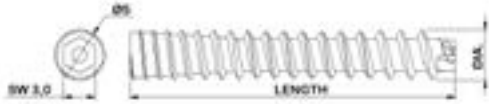

TI	DIA. x LENGTH (mm)
O6015030	5,0X30
O6015035	5,0X35
O6015040	5,0X40
O6015045	5,0X45
O6015050	5,0X50
O6015055	5,0X55
O6015060	5,0X60
O6015065	5,0X65
O6015070	5,0X70
O6015075	5,0X75
O6015080	5,0X80

6,5 mm Headless Cannulated Compression Screw



TI	DIA. x LENGTH (mm)
O6016540	6,5X40
O6016545	6,5X45
O6016550	6,5X50
O6016555	6,5X55
O6016560	6,5X60
O6016565	6,5X65
O6016570	6,5X70
O6016575	6,5X75
O6016580	6,5X80
O6016585	6,5X85
O6016590	6,5X90

3,0 / 4,0 mm Herbert Screw

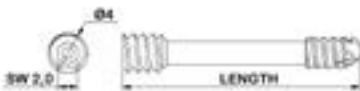

TI	LENGTH (mm)
O34,114	14
O34,116	16
O34,118	18
O34,120	20
O34,122	22
O34,124	24
O34,126	26
O34,128	28
O34,130	30
O34,132	32

Interference Screw

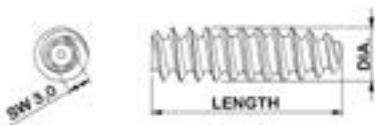

TI	DIA. (mm)	LENGTH (mm)	LENGTH (mm)	LENGTH (mm)
O6072710	7	20	25	30
O6072712	8	20	25	30
O6072714	9	20	25	30
O6072716	10	20	25	30
O6072732	11	20	25	30



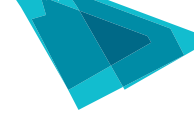

# TROCHANTERIC PLATES, CABLES, GRIPS

---

product  
group



4,5 / 5,0 mm Straight Cable Grip Plate

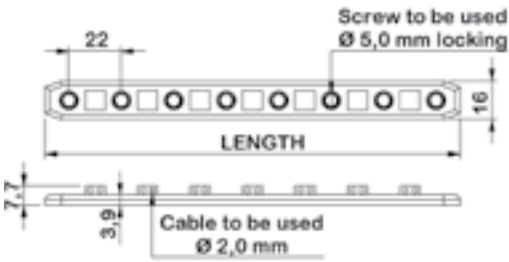

Cable to be used	Screw to be used	Thickness (mm)	Width (mm)
Ø (2,0 mm)	Ø (4,5 / 5,0 mm)	7,7	16
SS	HOLES	LENGTH (mm)	TYPE
O900 04 020 0051	8	174	Small
O900 04 020 0052	10	218	Medium
O900 04 020 0053	12	262	Large

4,5 / 5,0 mm Trochanteric Cable Hook Plate 1

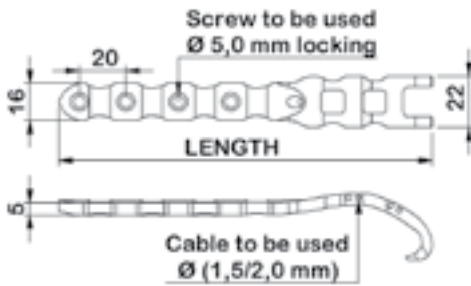

Cable to be used	Screw to be used	Thickness (mm)	Width (mm)
Ø (1,5 / 2,0 mm)	Ø (4,5 / 5,0 mm)	5,0	16,0 - 22,0
TI	HOLES	LENGTH (mm)	TYPE
O900 04 021 0051	3	115	Small
O900 04 021 0052	5	160	Medium
O900 04 021 0053	7	205	Large

4,5 / 5,0 mm Trochanteric Cable Hook Plate 2

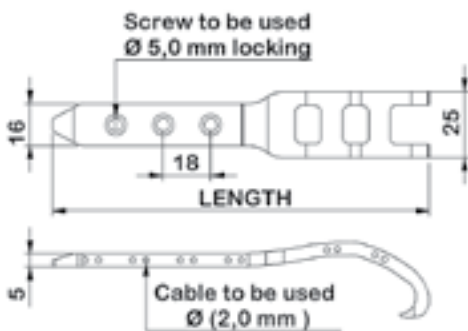

Cable to be used	Screw to be used	Thickness (mm)	Width (mm)
Ø (2,0 mm)	Ø (4,5 / 5,0 mm)	5	16,0 - 25,0
TI	HOLES	LENGTH (mm)	TYPE
O900 04 023 0051	1	96,9	Small
O900 04 023 0052	3	142,9	Medium
O900 04 023 0053	6	188,9	Large

Trochanteric Cable Hook Grip Plate

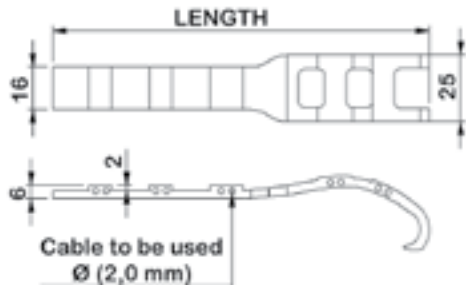

Cable to be used	Thickness (mm)	Width (mm)
Ø (2,0 mm)	6,0	16,0 - 25,0
SS	LENGTH (mm)	TYPE
O900 04 022 0051	113,2	Small
O900 04 022 0052	158,6	Medium
O900 04 022 0053	204	Large

3,5 mm Cable Locking Screw



TI  
O900 03 020 0005

5,0 mm Cable Locking Screw



TI  
O900 03 020 0008

Cable - Crimp Block

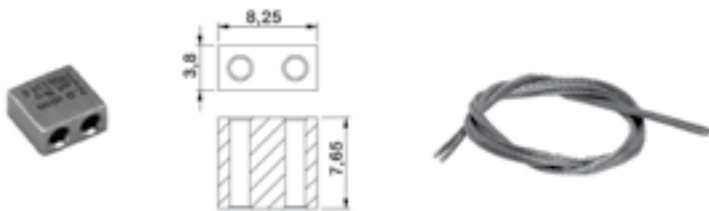

SS	TYPE
O900 03 015 0015	CABLE 1,5 mm
O900 03 020 0020	CABLE 2,0 mm
O900 04 015 0015	CRIMP BLOCK 1,5 mm
O900 04 020 0020	CRIMP BLOCK 2,0 mm

Trochanteric Grip

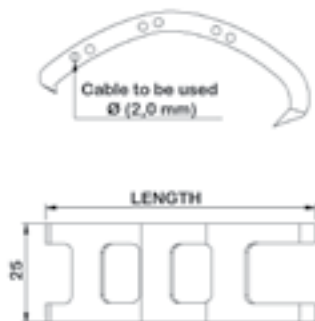

SS/TI	LENGTH (mm)
O900 04 020 0050	67,5





# INTRAMEDULLARY NAILS

---

product  
groups



## Humerus Intramedullary Nail

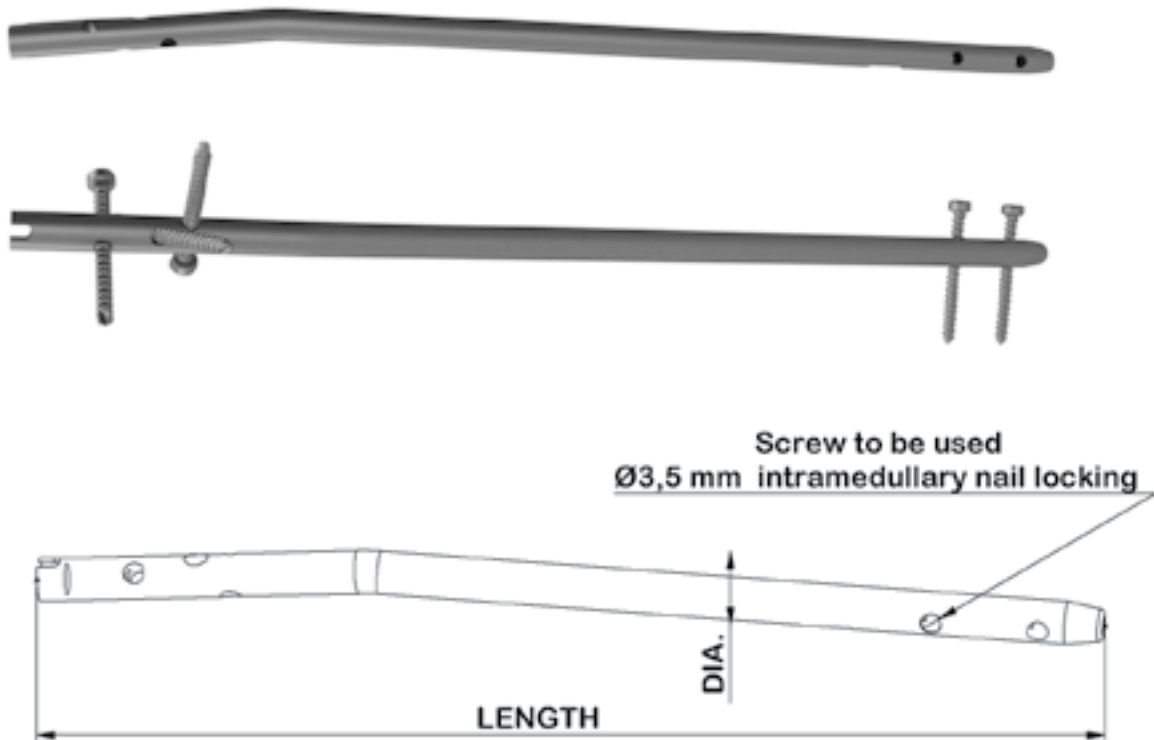

SS	TI	DIA. x LENGTH (mm)	SS	TI	DIA. x LENGTH (mm)
O100 03 036 0718	O100 03 035 0718	7X180	O100 03 036 1018	O100 03 035 1018	8,5X180
O100 03 036 0720	O100 03 035 0720	7X200	O100 03 036 1020	O100 03 035 1020	8,5X200
O100 03 036 0722	O100 03 035 0722	7X220	O100 03 036 1022	O100 03 035 1022	8,5X220
O100 03 036 0724	O100 03 035 0724	7X240	O100 03 036 1024	O100 03 035 1024	8,5X240
O100 03 036 0726	O100 03 035 0726	7X260	O100 03 036 1026	O100 03 035 1026	8,5X260
O100 03 036 0728	O100 03 035 0728	7X280	O100 03 036 1028	O100 03 035 1028	8,5X280
O100 03 036 0730	O100 03 035 0730	7X300	O100 03 036 1030	O100 03 035 1030	8,5X300
O100 03 036 0732	O100 03 035 0732	7X320	O100 03 036 1032	O100 03 035 1032	8,5X320
SS	TI	DIA. x LENGTH (mm)	SS	TI	DIA. x LENGTH (mm)
O100 03 036 0818	O100 03 035 0818	8X180	O100 03 036 0918	O100 03 035 0918	9X180
O100 03 036 0820	O100 03 035 0820	8X200	O100 03 036 0920	O100 03 035 0920	9X200
O100 03 036 0822	O100 03 035 0822	8X220	O100 03 036 0922	O100 03 035 0922	9X220
O100 03 036 0824	O100 03 035 0824	8X240	O100 03 036 0924	O100 03 035 0924	9X240
O100 03 036 0826	O100 03 035 0826	8X260	O100 03 036 0926	O100 03 035 0926	9X260
O100 03 036 0828	O100 03 035 0828	8X280	O100 03 036 0928	O100 03 035 0928	9X280
O100 03 036 0830	O100 03 035 0830	8X300	O100 03 036 0930	O100 03 035 0930	9X300
O100 03 036 0832	O100 03 035 0832	8X320	O100 03 036 0932	O100 03 035 0932	9X320

## 3,5 mm Intramedullary Nail Locking Screw

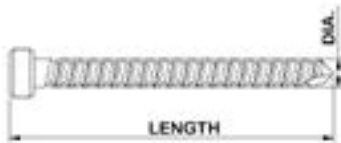

SS	TI	DIA. x LENGTH (mm)
O101 03 036 4020	O101 03 035 4020	3,5X20
O101 03 036 4025	O101 03 035 4025	3,5X25
O101 03 036 4030	O101 03 035 4030	3,5X30
O101 03 036 4035	O101 03 035 4035	3,5X35
O101 03 036 4040	O101 03 035 4040	3,5X40
O101 03 036 4045	O101 03 035 4045	3,5X45
O101 03 036 4050	O101 03 035 4050	3,5X50

## Humerus Intramedullary Nail End Cap

SS	TI
O100 03 201 0000	O100 03 202 0000



## Femur Intramedullary Nail (ANTEGRADE)

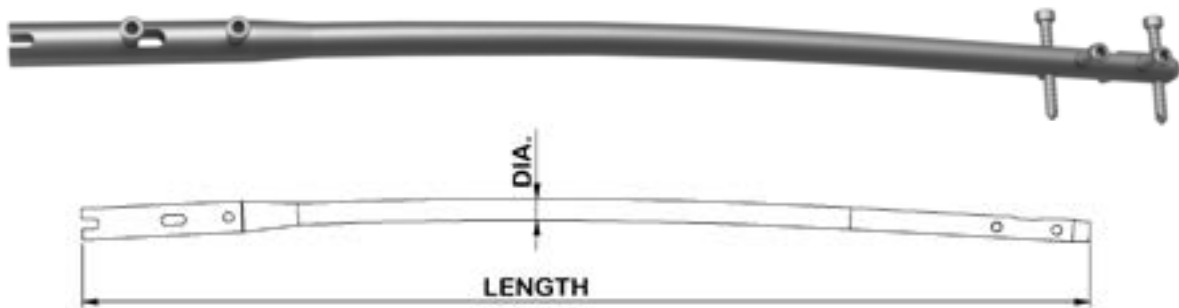

SS	TI	DIA. x LENGTH (mm)	SS	TI	DIA. x LENGTH (mm)
O4099320	O4089320	9X320	O4090320	O4080320	10X320
O4099340	O4089340	9X340	O4090340	O4080340	10X340
O4099360	O4089360	9X360	O4090360	O4080360	10X360
O4099380	O4089380	9X380	O4090380	O4080380	10X380
O4099400	O4089400	9X400	O4090400	O4080400	10X400
O4099420	O4089420	9X420	O4090420	O4080420	10X420
O4099440	O4089440	9X440	O4090440	O4080440	10X440
O4099460	O4089460	9X460	O4090460	O4080460	10X460
SS	TI	DIA. x LENGTH (mm)	SS	TI	DIA. x LENGTH (mm)
O4091320	O4081320	11X320	O4092320	O4082320	12X320
O4091340	O4081340	11X340	O4092340	O4082340	12X340
O4091360	O4081360	11X360	O4092360	O4082360	12X360
O4091380	O4081380	11X380	O4092380	O4082380	12X380
O4091400	O4081400	11X400	O4092400	O4082400	12X400
O4091420	O4081420	11X420	O4092420	O4082420	12X420
O4091440	O4081440	11X440	O4092440	O4082440	12X440
O4091460	O4081460	11X460	O4092460	O4082460	12X460
SS	TI	DIA. x LENGTH (mm)	SS	TI	DIA. x LENGTH (mm)
O4093320	O4083320	13X320	O4094320	O4084320	14X320
O4093340	O4083340	13X340	O4094340	O4084340	14X340
O4093360	O4083360	13X360	O4094360	O4084360	14X360
O4093380	O4083380	13X380	O4094380	O4084380	14X380
O4093400	O4083400	13X400	O4094400	O4084400	14X400
O4093420	O4083420	13X420	O4094420	O4084420	14X420
O4093440	O4083440	13X440	O4094440	O4084440	14X440
O4093460	O4083460	13X460	O4094460	O4084460	14X460
SS	TI	DIA. x LENGTH (mm)	SS	TI	DIA. x LENGTH (mm)
O4095320	O4085320	15X320	O4096320	O4086320	16X320
O4095340	O4085340	15X340	O4096340	O4086340	16X340
O4095360	O4085360	15X360	O4096360	O4086360	16X360
O4095380	O4085380	15X380	O4096380	O4086380	16X380
O4095400	O4085400	15X400	O4096400	O4086400	16X400
O4095420	O4085420	15X420	O4096420	O4086420	16X420
O4095440	O4085440	15X440	O4096440	O4086440	16X440
O4095460	O4085460	15X460	O4096460	O4086460	16X460

\* DIA. Means DIAMETER

4,5 mm Intramedullary Nail Locking Screw

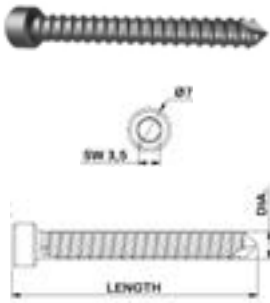

SS	TI	DIA. x LENGTH (mm)
O4194020	O4184020	4,5X20
O4194025	O4184025	4,5X25
O4194030	O4184030	4,5X30
O4194035	O4184035	4,5X35
O4194040	O4184040	4,5X40
O4194045	O4184045	4,5X45
O4194050	O4184050	4,5X50
O4194055	O4184055	4,5X55
O4194060	O4184060	4,5X60
O4194065	O4184065	4,5X65
O4194070	O4184070	4,5X70
O4194075	O4184075	4,5X75

Femur Intramedullary Nail End Cap



SS	TI
O100 03 040 4900	O100 03 040 5000

Distal Femur Intramedullary Nail (DFN / RETROGRADE)

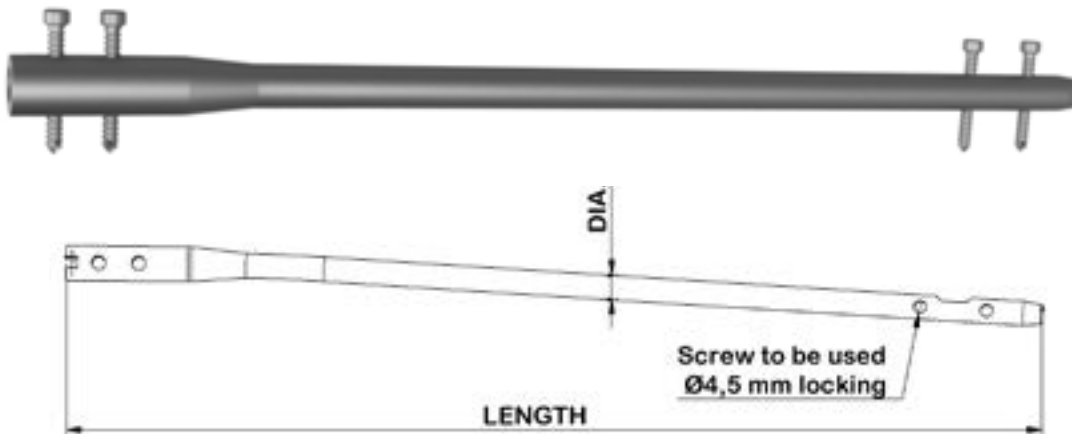

SS	TI	DIA. x LENGTH (mm)
O4499200	O4489200	9X200
O4499220	O4489220	9X220
O4499240	O4489240	9X240
O4499260	O4489260	9X260

SS	TI	DIA. x LENGTH (mm)
O4490200	O4480200	10X200
O4490220	O4480220	10X220
O4490240	O4480240	10X240
O4490260	O4480260	10X260

SS	TI	DIA. x LENGTH (mm)
O4491200	O4481200	11X200
O4491220	O4481220	11X220
O4491240	O4481240	11X240
O4491260	O4481260	11X260

SS	TI	DIA. x LENGTH (mm)
O4490300	O4480300	12X200
O4490320	O4480320	12X220
O4490340	O4480340	12X240
O4490360	O4480360	12X260

SS	TI	DIA. x LENGTH (mm)
O4491300	O4481300	13X200
O4491320	O4481320	13X220
O4491340	O4481340	13X240
O4491360	O4481360	13X260



4,5 mm Intramedullary Nail Locking Screw

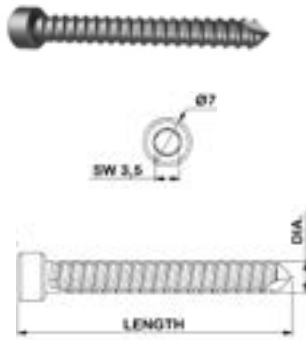

SS	TI	DIA. x LENGTH (mm)
O4194020	O4184020	4,5X20
O4194025	O4184025	4,5X25
O4194030	O4184030	4,5X30
O4194035	O4184035	4,5X35
O4194040	O4184040	4,5X40
O4194045	O4184045	4,5X45
O4194050	O4184050	4,5X50
O4194055	O4184055	4,5X55
O4194060	O4184060	4,5X60
O4194065	O4184065	4,5X65
O4194070	O4184070	4,5X70
O4194075	O4184075	4,5X75

Distal Femur Intramedullary Nail (DFN / Retrograde) End Cap



SS	TI
O100 03 040 4700	O100 03 040 4800

Femur Short Reconstruction Intramedullary Nail (PFN)

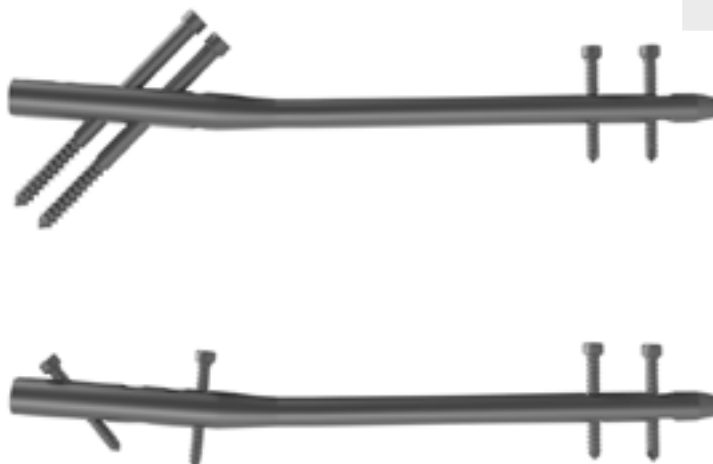

TI	DIA. x LENGTH (mm)
O4289240	9X240
O4280240	10X240
O4281240	11X240
O3282240	12X240

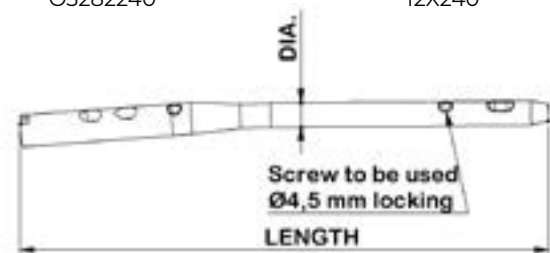

\* DIA. Means DIAMETER

## Femur Long Reconstruction Intramedullary Nail

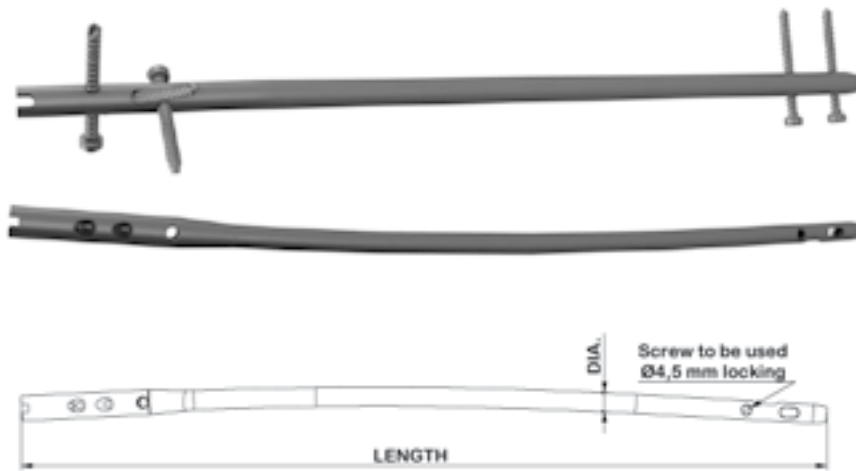

TI	DIA. x LENGTH (mm)	SIDE
O4389340	9X340	Left
O4389360	9X360	Left
O4389380	9X380	Left
O4389400	9X400	Left
O4389420	9X420	Left

TI	DIA. x LENGTH (mm)	SIDE
O4399340	9X340	Right
O4399360	9X360	Right
O4399380	9X380	Right
O4399400	9X400	Right
O4399420	9X420	Right

TI	DIA. x LENGTH (mm)	SIDE
O4380340	10X340	Left
O4380360	10X360	Left
O4380380	10X380	Left
O4380400	10X400	Left
O4380420	10X420	Left

TI	DIA. x LENGTH (mm)	SIDE
O4390340	10X340	Right
O4390360	10X360	Right
O4390380	10X380	Right
O4390400	10X400	Right
O4390420	10X420	Right

TI	DIA. x LENGTH (mm)	SIDE
O4381340	11X340	Left
O4381360	11X360	Left
O4381380	11X380	Left
O4381400	11X400	Left
O4381420	11X420	Left

TI	DIA. x LENGTH (mm)	SIDE
O4391340	11X340	Right
O4391360	11X360	Right
O4391380	11X380	Right
O4391400	11X400	Right
O4391420	11X420	Right

TI	DIA. x LENGTH (mm)	SIDE
O4382340	12X340	Left
O4382360	12X360	Left
O4382380	12X380	Left
O4382400	12X400	Left
O4382420	12X420	Left

TI	DIA. x LENGTH (mm)	SIDE
O4392340	12X340	Right
O4392360	12X360	Right
O4392380	12X380	Right
O4392400	12X400	Right
O4392420	12X420	Right

TI	DIA. x LENGTH (mm)	SIDE
O4383340	13X340	Left
O4383360	13X360	Left
O4383380	13X380	Left
O4383400	13X400	Left
O4383420	13X420	Left

TI	DIA. x LENGTH (mm)	SIDE
O4393340	13X340	Right
O4393360	13X360	Right
O4393380	13X380	Right
O4393400	13X400	Right
O4393420	13X420	Right

## Femur Long Reconstruction Intramedullary Nail Lag Screw

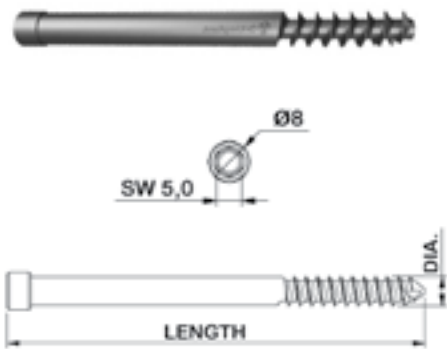

TI	DIA. x LENGTH (mm)
O4385065	6,4X65
O4385070	6,4X70
O4385075	6,4X75
O4385080	6,4X80
O4385085	6,4X85
O4385090	6,4X90
O4385095	6,4X95
O4385100	6,4X100
O4385105	6,4X105
O4385110	6,4X110
O4385115	6,4X115
O4385120	6,4X120

## Femur Long Reconstruction Intramedullary Nail End Cap



TI  
O3184030

## 4,5 mm Intramedullary Nail Locking Screw



TI	DIA. x LENGTH (mm)
O4184020	4,5X20
O4184025	4,5X25
O4184030	4,5X30
O4184035	4,5X35
O4184040	4,5X40
O4184045	4,5X45
O4184050	4,5X50
O4184055	4,5X55
O4184060	4,5X60
O4184065	4,5X65
O4184070	4,5X70
O4184075	4,5X75

## APFNA Femur Short Intramedullary Nail

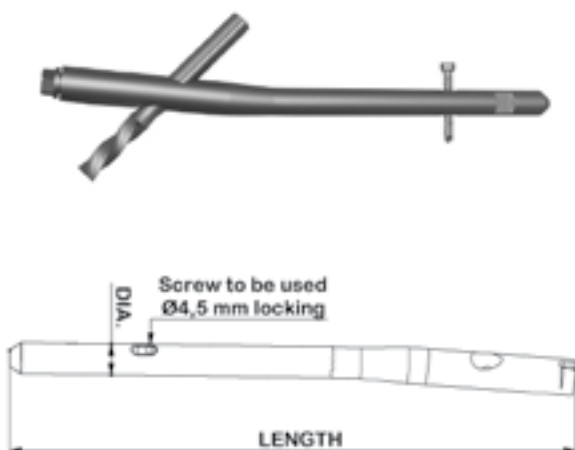

TI	DIA. x LENGTH (mm)
O3080320	9X180
O3080340	9X200
O3080360	9X240
O3080380	10X180
O3080400	10X200
O3080420	10X240
O3080440	11X180
O3080460	11X200
O3081320	11X240
O3081340	12X180
O3081360	12X200
O3081380	12X240
O3081400	13X180
O3081420	13X200
O3081440	13X240
O3081460	14X180
O3082320	14X200
O3082340	14X240

## APFNA Intramedullary Nail End Cap



TI	LENGTH (mm)
O3184020	26
O3184025	40

## APFNA Intramedullary Nail Blade Screw



TI	DIA. x LENGTH (mm)	TI	DIA. x LENGTH (mm)
O3395075	10,4X75	O3395100	10,4X100
O3395080	10,4X80	O3395105	10,4X105
O3395085	10,4X85	O3395110	10,4X110
O3395090	10,4 X90	O3395115	10,4X115
O3395095	10,4X95	O3395120	10,4X120

## AROCOM Proximal Femur Anti - Rotation Compression Intramedullary Nail

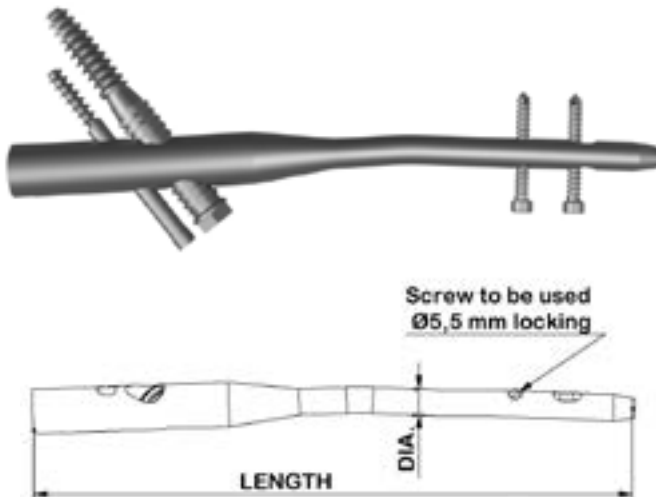

TI	DIA. x LENGTH (mm)
O3089320	10X220
O3089340	11X220
O3089360	12X220
O3089380	13X220

## AROCOM Proximal Femur Anti - Rotation Intramedullary Nail End Cap



TI
O3184035

## AROCOM Proximal Femur Anti - Rotation Intramedullary Nail Compression Screw



TI	LENGTH (mm)
O3184040	35

**AROCOM Proximal Femur Anti - Rotation Intramedullary Nail Lag Screw**

TI	DIA. x LENGTH (mm)
O3082360	10x75
O3082380	10x80
O3082400	10x85
O3082420	10x90
O3082440	10x95
O3082460	10x100
O3083320	10x105
O3083340	10x110
O3083360	10x115
O3083380	10x120
O3083400	10x125
O3083420	10x130

**AROCOM Proximal Femur Anti - Rotation Intramedullary Nail Anti - Rotation Screw**

TI	DIA. x LENGTH (mm)
O3083460	6x65
O3084320	6x70
O3084340	6x75
O3084360	6x80
O3084380	6x85
O3084400	6x90
O3084420	6x95
O3084440	6x100
O3084460	6x105
O3085320	6x110
O3085340	6x115
O3085360	6x120
O3085380	6x125
O3085400	6x130

**AROCOM Proximal Femur Anti - Rotation Intramedullary Nail Connection Sleeve**

TI	DIA. x LENGTH (mm)
O3083440	12x52

**AROCOM Proximal Femur Anti - Rotation Intramedullary Nail Locking Screw**

TI	DIA. x LENGTH (mm)	TI	DIA. x LENGTH (mm)
O3085420	5,5X26	O3086400	5,5X40
O3085440	5,5X28	O3086420	5,5X42
O3085460	5,5X30	O3086440	5,5X44
O3086320	5,5X32	O3086460	5,5X46
O3086340	5,5X34	O4283240	5,5X48
O3086360	5,5X36	O4284240	5,5X50
O3086380	5,5X38		

**ANTIRO Proximal Femur Anti - Rotation Intramedullary Nail**

TI	DIA. x LENGTH (mm)
O3089400	10X220
O3089420	11X220
O3089440	12X220
O3089460	13X220

ANTIRO Proximal Femur Anti - Rotation  
Intramedullary Nail End Cap

TI  
O3184045

ANTIRO Proximal Femur Anti - Rotation  
Intramedullary Nail Compression Screw

TI  
O3184050

ANTIRO Proximal Femur Anti - Rotation  
Intramedullary Nail Lag Screw

TI	DIA. x LENGTH (mm)
O4384320	11,5x75
O4384340	11,5x80
O4384360	11,5x85
O4384380	11,5x90
O4384400	11,5x95
O4384420	11,5x100
O4384440	11,5x105
O4384460	11,5x110
O4385320	11,5x115
O4385340	11,5x120

ANTIRO Proximal Femur Anti - Rotation  
Intramedullary Nail Pin

TI	DIA. x LENGTH (mm)
O4385360	5x75
O4385380	5x80
O4385400	5x85
O4385420	5x90
O4385440	5x95
O4385460	5x100
O4386320	5x105
O4386340	5x110
O4386360	5x115
O4386380	5x120

## ANTIRO Proximal Femur Anti - Rotation Intramedullary Nail Locking Screw



TI	DIA. x LENGTH (mm)
O43879320	5x20
O43879340	5x25
O43879360	5x30
O43879380	5x35
O43879400	5x40
O43879420	5x45
O43879440	5x50
O43879460	5x55
O43870320	5x60
O43870340	5x65
O43870360	5x70
O43870380	5x75

## Tibia Intramedullary Nail

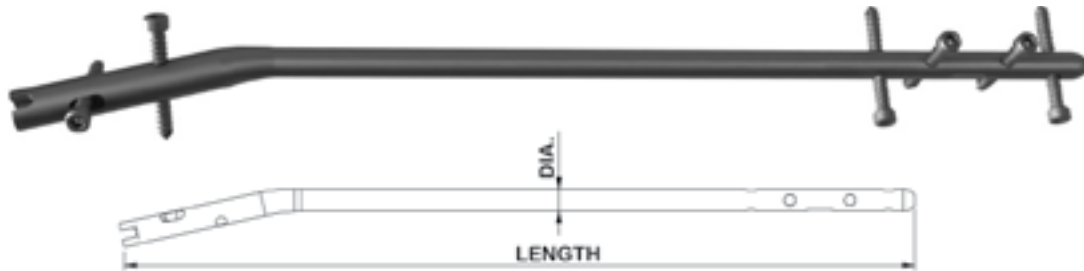

SS	TI	DIA. x LENGTH (mm)	SS	TI	DIA. x LENGTH (mm)
O4199260	O4189260	8 X 255	O4190260	O4180260	9 X 255
O4199280	O4189280	8 X 270	O4190280	O4180280	9 X 270
O4199300	O4189300	8 X 285	O4190300	O4180300	9 X 285
O4199320	O4189320	8 X 300	O4190320	O4180320	9 X 300
O4199340	O4189340	8 X 315	O4190340	O4180340	9 X 315
O4199360	O4189360	8 X 330	O4190360	O4180360	9 X 330
O4199380	O4189380	8 X 345	O4190380	O4180380	9 X 345
O4199400	O4189400	8 X 360	O4190400	O4180400	9 X 360
O3199340	O3189340	8 X 375	O3190340	O3180340	9 X 375
O3199360	O3189360	8 X 390	O3190360	O3180360	9 X 390
O3199380	O3189380	8 X 405	O3190380	O3180380	9 X 405
O3199400	O3189400	8 X 420	O3190400	O3180400	9 X 420
SS	TI	DIA. x LENGTH (mm)	SS	TI	DIA. x LENGTH (mm)
O4191260	O4181260	10 X 255	O4192260	O4182260	11 X 255
O4191280	O4181280	10 X 270	O4192280	O4182280	11 X 270
O4191300	O4181300	10 X 285	O4192300	O4182300	11 X 285
O4191320	O4181320	10 X 300	O4192320	O4182320	11 X 300
O4191340	O4181340	10 X 315	O4192340	O4182340	11 X 315
O4191360	O4181360	10 X 330	O4192360	O4182360	11 X 330
O4191380	O4181380	10 X 345	O4192380	O4182380	11 X 345
O4191400	O4181400	10 X 360	O4192400	O4182400	11 X 360
O3191340	O3181340	10 X 375	O3192340	O3182340	11 X 375
O3191360	O3181360	10 X 390	O3192360	O3182360	11 X 390
O3191380	O3181380	10 X 405	O3192380	O3182380	11 X 405
O3191400	O3181400	10 X 420	O3192400	O3182400	11 X 420
SS	TI	DIA. x LENGTH (mm)	SS	TI	DIA. x LENGTH (mm)
O4193260	O4183260	12 X 255	O4194260	O4184260	13 X 255
O4193280	O4183280	12 X 270	O4194280	O4184280	13 X 270
O4193300	O4183300	12 X 285	O4194300	O4184300	13 X 285
O4193320	O4183320	12 X 300	O4194320	O4184320	13 X 300
O4193340	O4183340	12 X 315	O4194340	O4184340	13 X 315
O4193360	O4183360	12 X 330	O4194360	O4184360	13 X 330
O4193380	O4183380	12 X 345	O4194380	O4184380	13 X 345
O4193400	O4183400	12 X 360	O4194400	O4184400	13 X 360
O3193340	O3183340	12 X 375	O3194340	O3184340	13 X 375
O3193360	O3183360	12 X 390	O3194360	O3184360	13 X 390
O3193380	O3183380	12 X 405	O3194380	O3184380	13 X 405
O3193400	O3183400	12 X 420	O3194400	O3184400	13 X 420

## ANT Tibia Intramedullary Nail



TI	DIA. x LENGTH (mm)	TI	DIA. x LENGTH (mm)	TI	DIA. x LENGTH (mm)
O100 03 037 2708	8X270	O100 03 037 2709	9X270	O100 03 037 2710	10X270
O100 03 037 2808	8X285	O100 03 037 2809	9X285	O100 03 037 2810	10X285
O100 03 037 3008	8X300	O100 03 037 3009	9X300	O100 03 037 3010	10X300
O100 03 037 3108	8X315	O100 03 037 3109	9X315	O100 03 037 3110	10X315
O100 03 037 3308	8X330	O100 03 037 3309	9X330	O100 03 037 3310	10X330
O100 03 037 3408	8X345	O100 03 037 3409	9X345	O100 03 037 3410	10X345
O100 03 037 3608	8X360	O100 03 037 3609	9X360	O100 03 037 3610	10X360
O100 03 037 3808	8X375	O100 03 037 3809	9X375	O100 03 037 3810	10X375
O100 03 037 4008	8X390	O100 03 037 4009	9X390	O100 03 037 4010	10X390
O100 03 037 4208	8X405	O100 03 037 4209	9X405	O100 03 037 4210	10X405
		O100 03 037 4409	9X420	O100 03 037 4410	10X420

TI	DIA. x LENGTH (mm)	TI	DIA. x LENGTH (mm)	TI	DIA. x LENGTH (mm)
O100 03 037 2711	11X270	O100 03 037 2712	12X270	O100 03 037 2813	13X285
O100 03 037 2811	11X285	O100 03 037 2812	12X285	O100 03 037 3013	13X300
O100 03 037 3011	11X300	O100 03 037 3012	12X300	O100 03 037 3113	13X315
O100 03 037 3111	11X315	O100 03 037 3112	12X315	O100 03 037 3313	13X330
O100 03 037 3311	11X330	O100 03 037 3312	12X330	O100 03 037 3413	13X345
O100 03 037 3411	11X345	O100 03 037 3412	12X345	O100 03 037 3613	13X360
O100 03 037 3611	11X360	O100 03 037 3612	12X360	O100 03 037 3813	13X375
O100 03 037 3811	11X375	O100 03 037 3812	12X375	O100 03 037 4013	13X390
O100 03 037 4011	11X390	O100 03 037 4012	12X390	O100 03 037 4213	13X405
O100 03 037 4211	11X405	O100 03 037 4212	12X405	O100 03 037 4413	13X420
O100 03 037 4411	11X420	O100 03 037 4412	12X420		

## 4,5 mm Intramedullary Nail Locking Screw



SS	TI	DIA. x LENGTH (mm)
O4194020	O4184020	4,5X20
O4194025	O4184025	4,5X25
O4194030	O4184030	4,5X30
O4194035	O4184035	4,5X35
O4194040	O4184040	4,5X40
O4194045	O4184045	4,5X45
O4194050	O4184050	4,5X50
O4194055	O4184055	4,5X55
O4194060	O4184060	4,5X60
O4194065	O4184065	4,5X65
O4194070	O4184070	4,5X70
O4194075	O4184075	4,5X75

## ANT Tibia Intramedullary Nail End Cap



TI  
O100 03 040 4600



## Elastic Nail

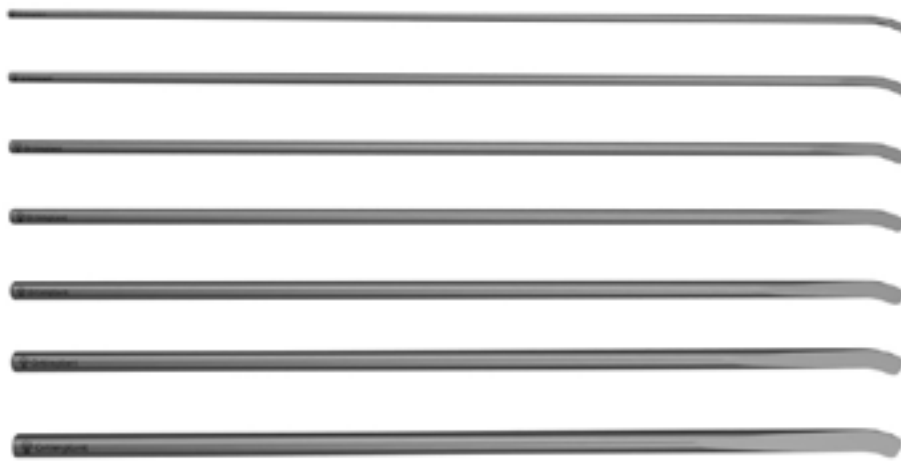

TI	DIA. x LENGTH (mm)
O45015440	1,5X440
O45020440	2,0X440
O45025440	2,5X440
O45030440	3,0X440
O45035440	3,5X440
O45040440	4,0X440
O45045440	4,5X440
O45050440	5,0X440
O45055440	5,5X440



## Elastic Nail End Cap



TI	DIA. x LENGTH (mm)
O45015	Ø 1,5
O45020	Ø 2,0
O45025	Ø 2,5
O45030	Ø 3,0
O45035	Ø 3,5
O45040	Ø 4,0
O45045	Ø 4,5
O45050	Ø 5,0
O45055	Ø 5,5

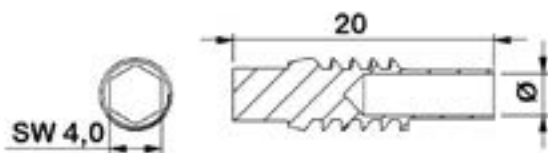



# DYNAMIC EXTERNAL FIXATORS

---

product  
group



## Dynamic Axial External Fixator Femur - Tibia



Pin / Screw to be used			
Ø (5,0 / 5,5 / 6,0 mm)			
REF. NO.	TYPE	DISTRACTION (mm)	LENGTH (mm)
O600 11 100 0001	Long	60	270
O600 11 100 0002	Medium	40	250
O600 11 100 0003	Short	20	230

## Dynamic Axial External Fixator Femur - Tibia T - Clamp

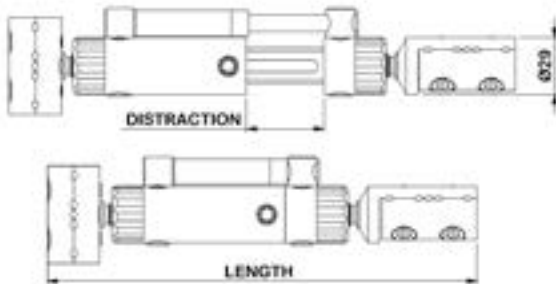

Pin / Screw to be used			
Ø (5,0 / 5,5 / 6,0 mm)			
REF. NO.	TYPE	DISTRACTION (mm)	LENGTH (mm)
O600 16 100 0006	Long	60	240
O600 16 100 0007	Medium	40	220
O600 16 100 0008	Short	20	200

## Dynamic Axial External Fixator Trochanteric Clamp (135°)

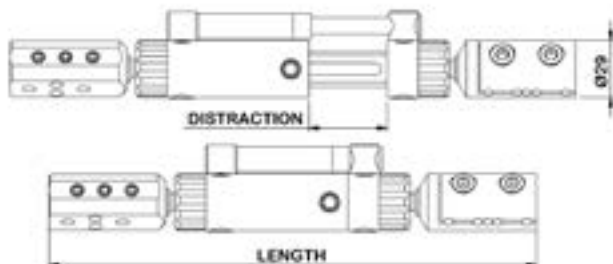

Pin / Screw to be used			
Ø (5,0 / 5,5 / 6,0 mm)			
REF. NO.	TYPE	DISTRACTION (mm)	LENGTH (mm)
O600 11 100 0040	Long	60	270
O600 11 100 0041	Medium	40	250
O600 11 100 0042	Short	20	230

## Dynamic Axial External Fixator Square Clamp Femur - Tibia

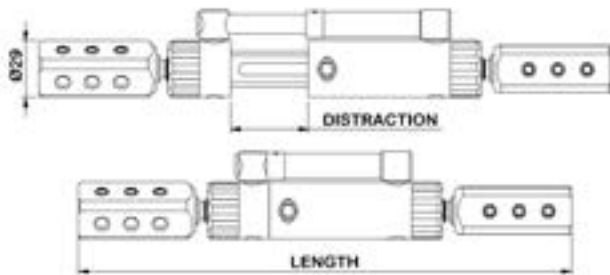

Pin / Screw to be used

Ø (5,0 / 5,5 / 6,0 mm)

REF. NO.	TYPE	DISTRACTION (mm)	LENGTH (mm)
O600 11 100 0140	Long	60	270
O600 11 100 0141	Medium	40	250
O600 11 100 0142	Short	20	230

## Limb Lengthening External Fixator Femur - Tibia

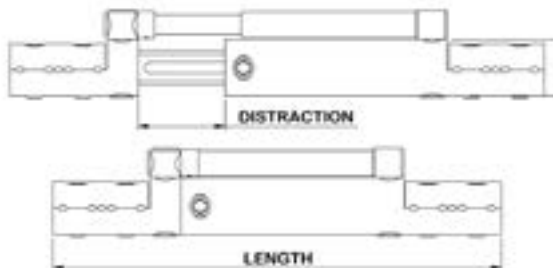

Pin / Screw to be used

Ø (5,0 / 5,5 / 6,0 mm)

REF. NO.	TYPE	DISTRACTION (mm)	LENGTH (mm)
O600 11 100 0020	Long	97	250
O600 11 100 0021	Medium	77	230
O600 11 100 0022	Short	57	210

## Dynamic Axial Ankle Fixator

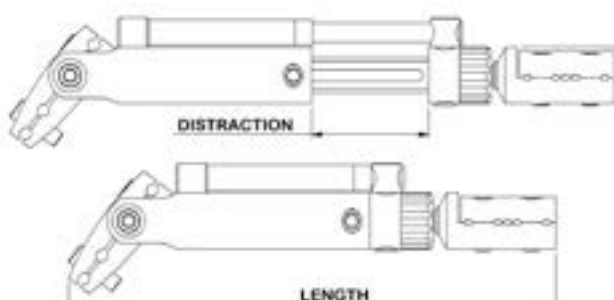

Pin / Screw to be used

Ø (5,0 / 5,5 / 6,0 mm)

REF. NO.	TYPE	DISTRACTION (mm)	LENGTH (mm)
O600 11 100 0004	Left - Long	80	275
O600 11 100 0005	Left - Medium	60	255
O600 11 100 0006	Left - Short	40	235
O600 11 101 0004	Right - Long	80	275
O600 11 101 0005	Right - Medium	60	255
O600 11 101 0006	Right - Short	40	235

Dynamic Axial External Fixator Humerus



Pin / Screw to be used			
Ø (4,0 / 4,5 / 5,0 mm)			
REF. NO.	TYPE	DISTRACTION (mm)	LENGTH (mm)
O600 16 100 0001	Long	51	235
O600 16 100 0002	Medium	31	215
O600 16 100 0003	Short	11	195

Dynamic Axial External Fixator T - Clamp Humerus



Pin / Screw to be used			
Ø (4,0 / 4,5 / 5,0 mm)			
REF. NO.	TYPE	DISTRACTION (mm)	LENGTH (mm)
O600 16 101 0001	Long	51	207
O600 16 101 0002	Medium	31	187
O600 16 101 0003	Short	11	167

Limb Lengthening External Fixator Humerus

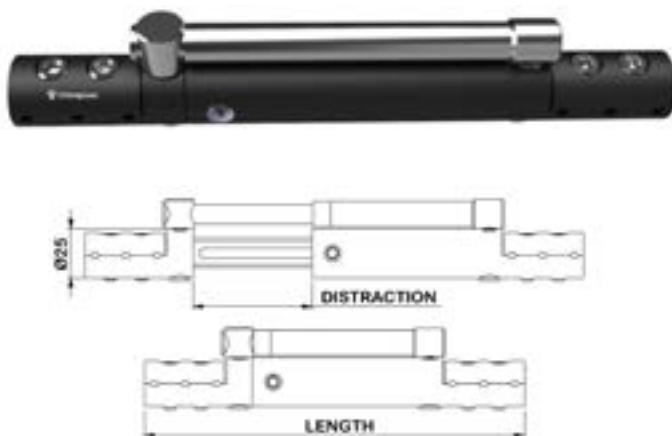

Pin / Screw to be used			
Ø (4,0 / 4,5 / 5,0 mm)			
REF. NO.	TYPE	DISTRACTION (mm)	LENGTH (mm)
O600 16 100 0010	Long	81	215
O600 16 100 0011	Medium	61	195
O600 16 100 0012	Short	41	175

Dynamic External Fixator Forearm

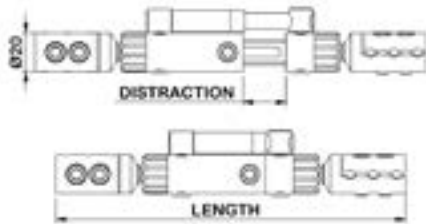

Pin / Screw to be used			
Ø (3,5 / 4,0 / 4,5 mm)			
REF. NO.	TYPE	DISTRACTION (mm)	LENGTH (mm)
O600 17 100 0001	Long	42	200
O600 17 100 0002	Medium	22	180
O600 17 100 0003	Short	14	168

Colles Type Wrist Fixator

Wrist Fixator

Pin / Screw to be used	
Ø (2,5 / 3,0 / 3,5 mm)	
REF. NO.	LENGTH (mm)
O600 12 110 0010	218

Pin / Screw to be used	
Ø (2,5 / 3,0 / 3,5 mm)	
REF. NO.	LENGTH (mm)
O600 12 110 0011	210

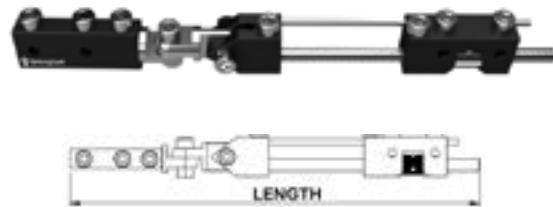
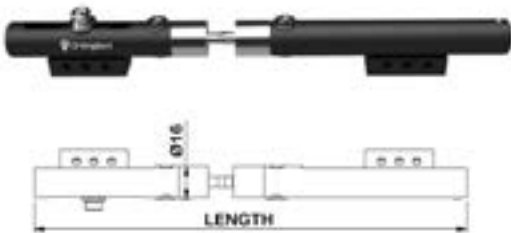

Penning Type Wrist Fixator

Pin / Screw to be used		
Ø (2,5 / 3,0 / 3,5 mm)		
REF. NO.	TYPE	LENGTH (mm)
O600 12 110 0012	Short	190
O600 12 110 0013	Long	220

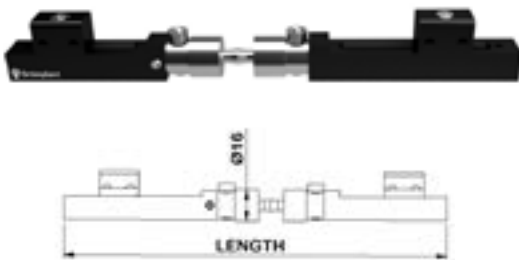

Pelvis Fixator

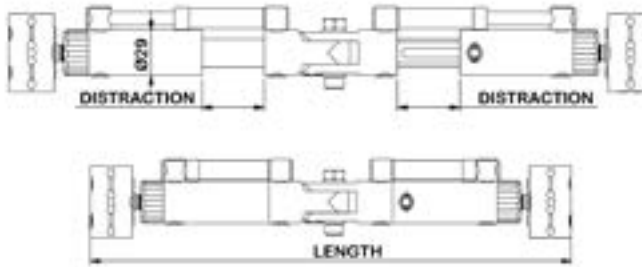

Pin / Screw to be used			
Ø (5,0 / 5,5 / 6,0 mm)			
REF. NO.	TYPE	DISTRACTION (mm)	LENGTH (mm)
O600 25 000 0000	Long	60	333
O600 25 000 0001	Standard	40	373

Pediatric Pelvis Fixator

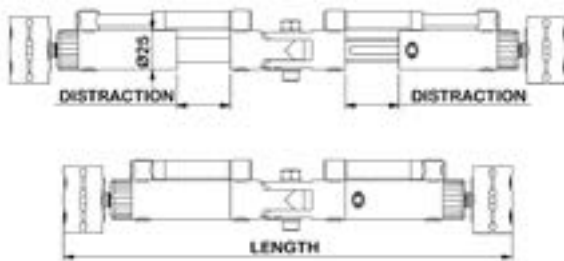

Pin / Screw to be used		
Ø (4,0 / 4,5 / 5,0 mm)		
REF. NO.	DISTRACTION (mm)	LENGTH (mm)
O600 25 000 0110	25	275

Dynamic Axial Elbow Fixator

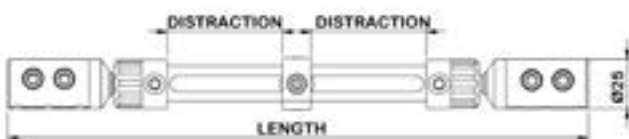

Pin / Screw to be used		
Ø (3,5 / 4,0 / 4,5 mm)		
REF. NO.	DISTRACTION (mm)	LENGTH (mm)
O600 15 100 0001	59	298

Dynamic Axial Knee Fixator

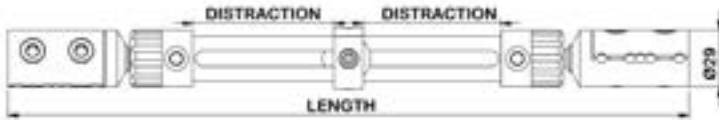

Pin / Screw to be used		
Ø (5,0 / 5,5 / 6,0 mm)		
REF. NO.	DISTRACTION (mm)	LENGTH (mm)
O600 15 100 0002	71,5	350

Limb Reconstruction Fixator Femur - Tibia

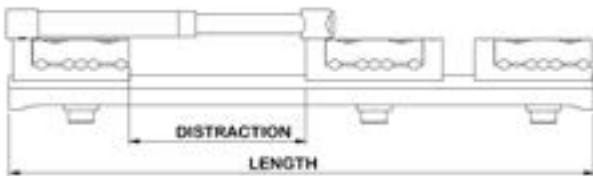

Pin / Screw to be used			
Ø (5,0 / 5,5 / 6,0 mm)			
REF. NO.	TYPE	DISTRACTION (mm)	LENGTH (mm)
O600 11 100 0010	Long	140	400
O600 11 100 0013	Medium	90	300
O600 11 100 0012	Short	40	250

Limb Reconstruction Pediatric Fixator

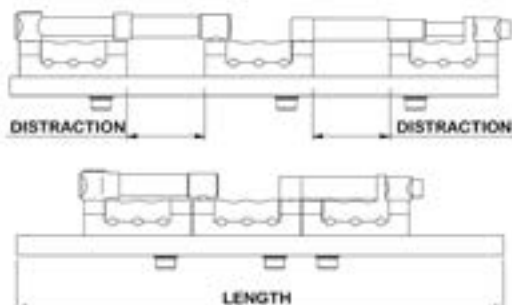

Pin / Screw to be used			
Ø (4,0 / 4,5 / 5,0 mm)			
REF. NO.	TYPE	DISTRACTION (mm)	LENGTH (mm)
O600 11 101 0010	Long	90	250
O600 11 101 0013	Medium	90	200
O600 11 101 0012	Short	45	150



Polyaxial Femur - Tibia External Fixator

Pin / Screw to be used

Ø (5,0 / 5,5 / 6,0 mm)

REF. NO.	LENGTH (mm)
O600 11 115 0000	245

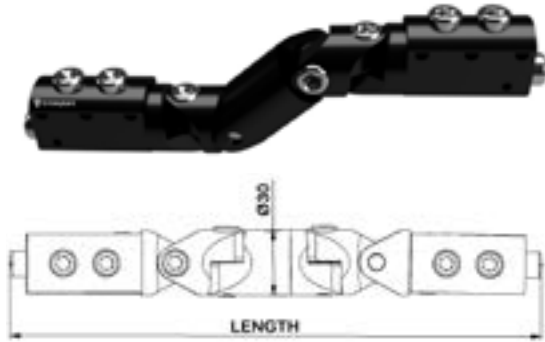

Polyaxial Humerus External Fixator

Pin / Screw to be used

Ø (4,0 / 4,5 / 5,0 mm)

REF. NO.	LENGTH (mm)
O600 11 120 0000	170

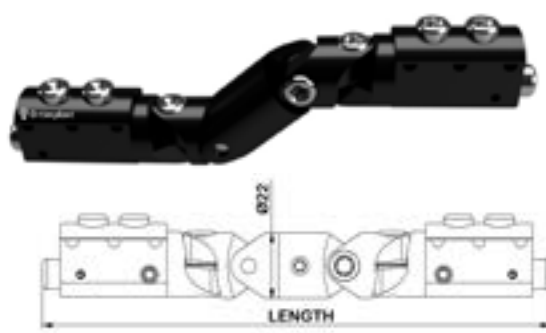

Petrochanteric Fixator

Pin / Screw to be used

Ø (5,0 / 5,5 / 6,0 mm)

REF. NO.	LENGTH (mm)
O600 12 120 0003	117,4

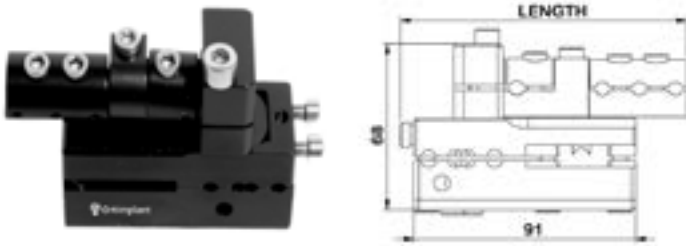

Hybrid External Fixator Femur - Tibia

Pin / Screw to be used

Ø (4,5 / 5,0 / 5,5 / 6,0 mm)

REF. NO.	LENGTH (mm)
O600 11 014 0005	230,5

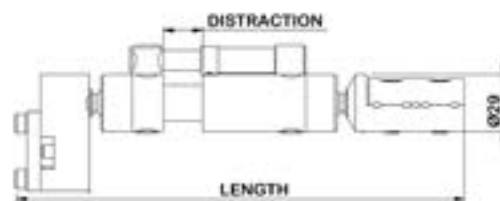

Hybrid External Fixator Wrist



Pin / Screw to be used	
Ø (3,0 / 3,5 / 4,0 mm)	
REF. NO.	LENGTH (mm)
O600 25 001 0025	174,3

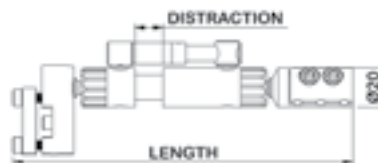

Hybrid External Fixator Finger



Pin / Screw to be used	
Ø (2,0 / 2,5 mm)	
REF. NO.	LENGTH (mm)
O600 25 001 0026	57,4

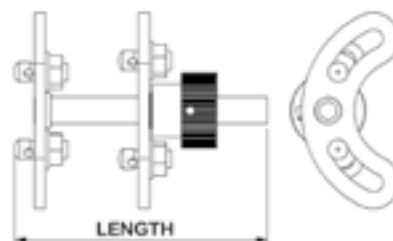

Finger Fixator



Pin / Screw to be used	
Ø (2,0 / 2,5 mm)	
REF. NO.	LENGTH (mm)
O600 12 120 0001	72,7

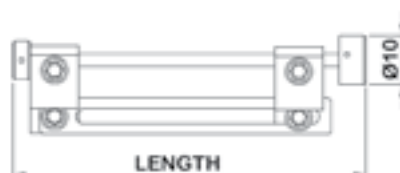



# MINI RAIL EXTERNAL FIXATORS

---

product  
group



## Mini Rail Fixator Short



Pin / Screw to be used		
Ø (1,5 / 2,0 / 2,5 mm)		
REF. NO.	DISTRACTION (mm)	LENGTH (mm)
O600 12 120 0005	19,5	71,5

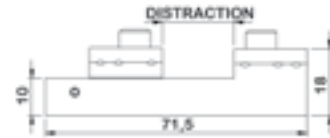

## Mini Rail Fixator Medium

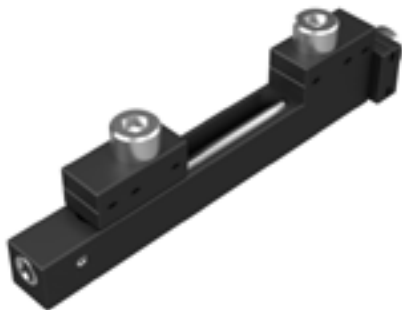

Pin / Screw to be used		
Ø (1,5 / 2,0 / 2,5 mm)		
REF. NO.	DISTRACTION (mm)	LENGTH (mm)
O600 12 120 0006	29,5	81,5

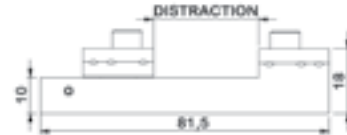

## Mini Rail Fixator Long

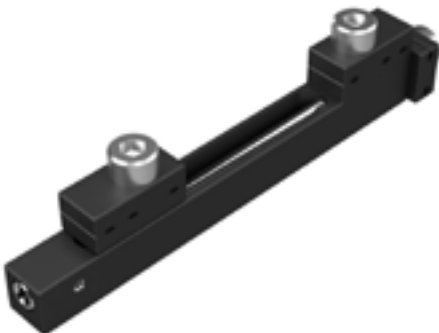

Pin / Screw to be used		
Ø (1,5 / 2,0 / 2,5 mm)		
REF. NO.	DISTRACTION (mm)	LENGTH (mm)
O600 12 120 0007	39,5	91,5

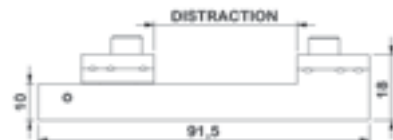

## Mini Rail Fixator X Long



Pin / Screw to be used		
Ø (1,5 / 2,0 / 2,5 mm)		
REF. NO.	DISTRACTION (mm)	LENGTH (mm)
O600 12 120 0002	69,5	121,5



## Mini Rail Fixator XX Long



Pin / Screw to be used		
Ø (1,5 / 2,0 / 2,5 mm)		
REF. NO.	DISTRACTION (mm)	LENGTH (mm)
O600 12 120 0000	106,5	158,5

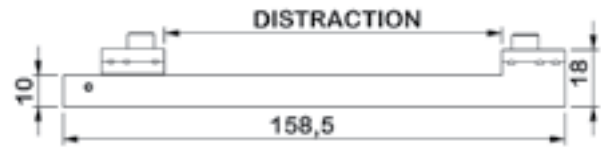

## Mini Rail Fixator Vertical Axis



Pin / Screw to be used		
Ø (1,5 / 2,0 / 2,5 mm)		
REF. NO.	DISTRACTION (mm)	LENGTH (mm)
O600 12 120 0009	11,7	71,5

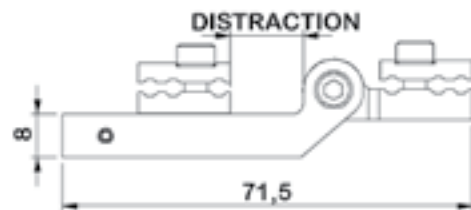

## Mini Rail Fixator Horizontal Axis



Pin / Screw to be used		
Ø (1,5 / 2,0 / 2,5 mm)		
REF. NO.	DISTRACTION (mm)	LENGTH (mm)
O600 12 120 0008	27,5	90

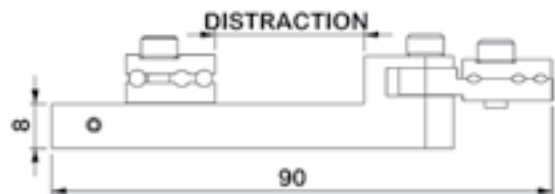

## Mini Rail Fixator Horizontal Axis 90°



Pin / Screw to be used		
Ø (1,5 / 2,0 / 2,5 mm)		
REF. NO.	DISTRACTION (mm)	LENGTH (mm)
O600 12 120 0010	27,5	91





---

# TUBULAR EXTERNAL FIXATORS

---

product  
group



## Tubular Fixator Carbon Rod



CARBON	DIA. x LENGTH (mm)
O600 11 005 0050	Ø 5X50
O600 11 005 0100	Ø 5X100
O600 11 005 0150	Ø 5X150
O600 11 005 0200	Ø 5X200
O600 11 005 0250	Ø 5X250
O600 11 005 0300	Ø 5X300
O600 11 005 0350	Ø 5X350
O600 11 006 0080	Ø 6X80
O600 11 006 0100	Ø 6X100
O600 11 006 0150	Ø 6X150
O600 11 006 0200	Ø 6X200
O600 11 006 0250	Ø 6X250
O600 11 006 0300	Ø 6X300
O600 11 006 0350	Ø 6X350
O600 11 008 0050	Ø 8X50
O600 11 008 0100	Ø 8X100
O600 11 008 0150	Ø 8X150

CARBON	DIA. x LENGTH (mm)
O600 11 008 0200	Ø 8X200
O600 11 008 0250	Ø 8X250
O600 11 008 0300	Ø 8X300
O600 11 008 0350	Ø 8X350
O600 11 010 0100	Ø 10X100
O600 11 010 0150	Ø 10X150
O600 11 010 0200	Ø 10X200
O600 11 010 0250	Ø 10X250
O600 11 010 0300	Ø 10X300
O600 11 010 0350	Ø 10X350
O600 11 014 0100	Ø 14X100
O600 11 014 0150	Ø 14X150
O600 11 014 0200	Ø 14X200
O600 11 014 0250	Ø 14X250
O600 11 014 0300	Ø 14X300
O600 11 014 0350	Ø 14X350

## Tubular Fixator Rod - Rod Clamp



ALUMINIUM	DIA. (mm)
O600 11 006 0001	5,0
O600 11 014 0001	8,0
O600 11 010 0001	10,0

## Tubular Fixator Rod - Pin Clamp



ALUMINIUM	DIA. (mm)
O600 11 006 0002	5,0
O600 11 014 0002	8,0
O600 11 010 0002	10,0

## Tubular Fixator Multiple Pin Clamp



ALUMINIUM	DIA. (mm)
O600 11 006 0003	5,0
O600 11 014 0003	8,0
O600 11 010 0003	10,0

## Tubular Fixator Straight Support



SS	DIA. (mm)
O600 11 005 0004	5,0
O600 11 008 0004	8,0
O600 11 010 0007	10,0

## Tubular Fixator 30° Angled Support



SS	DIA. (mm)
O600 29 121 0120	5,0
O600 29 121 0080	8,0
O600 29 121 0100	10,0

## Tubular Fixator Multiple Pin T Clamp



ALUMINIUM	DIA. (mm)
O600 11 006 0004	5,0
O600 11 014 0004	8,0
O600 11 010 0004	10,0



## Tubular Fixator Semi Circular Rod



SS	DIA. x LENGTH (mm)
O600 10 151 0160	Ø 8x160
O600 10 151 0180	Ø 8x180
O600 10 151 0200	Ø 8x200
O600 10 121 0160	Ø 10x160
O600 10 121 0180	Ø 10x180
O600 10 121 0200	Ø 10x200

## Tubular Fixator Compression Distraction Tube



ALUMINIUM	DIA. x LENGTH (mm)
O600 11 007 0022	Ø 8x200

## Tubular Fixator Ankle Hinge



SS	DIA. x LENGTH (mm)
O600 11 007 0020	Ø 8x200

## Tubular Fixator Elbow - Wrist Hinge



SS	DIA. x LENGTH (mm)
O600 11 007 0019	Ø 5x200



# HYBRID EXTERNAL FIXATORS

---

product  
group



## Hybrid Fixator Aluminium 2 / 3 Ring



REF. NO.	DIA. (mm)
O600 11 007 0014	155
O600 11 007 0016	185
O600 11 007 0018	215

## Hybrid Fixator Aluminium 1 / 3 Ring



REF. NO.	DIA. (mm)
O600 11 008 0014	155
O600 11 008 0016	185
O600 11 008 0018	215

## Hybrid Fixator Three Hole Sliding Wire Clamp

REF. NO.
O600 11 008 0026



## Washer

SS	DIA. (mm)
O600 10 030 0012	12
O600 10 030 0013	14



## Hybrid Fixator Two Hole Wire Securing Pin



REF. NO.
O600 10 153 0001

## Olive Wire



REF. NO.	DIA. x LENGTH (mm)
O600 10 188 2030	2,0X300
O600 10 188 2040	2,0X400

## Trocar Pointed Wire



SS	DIA. (mm)	LENGTH (mm)
O600 10 100 2030	2,0	300
O600 10 100 2040	2,0	400

## Hybrid Fixator Independent Wire Clamp

REF. NO.  
O600 11 008 0024



## Hybrid Fixator Supplementary Pin Holder Clamp

REF. NO.  
O600 11 008 0025



## Hybrid Fixator Carbon Rod



REF. NO.  
O600 11 006 0060

## Wire Fixation Bolt 25 / 30 mm



SS  
O600 10 090 0000

Hybrid Fixator Straight Posts



SS

O600 11 008 0021

Hybrid Fixator 30° Angled Posts



SS

O600 11 008 0022

Half Pin Universal Retaining Bolt

SS

O600 10 099 0001



Connection Bolt (M6)

SS

LENGTH (mm)

O600 10 020 0025

25

O600 10 020 0030

30



Spiked Washer

SS

O600 10 032 0000



Nut M6

SS

O600 10 021 0000



Hybrid Fixator Single Pin Clamp

SS

O600 11 007 0012



Hybrid Fixator Hinge Clamp

REF. NO.

O600 11 008 0019



\* DIA. Means DIAMETER

## Hybrid Fixator Kit

REF. NO.

O600 11 007 0023



## Hybrid Fixator Telescopic Reduction Unit

REF. NO.

O600 11 007 0021



## Hybrid Fixator Translation Rotation Hinge

REF. NO.

O600 11 008 0020



## Square Socket

REF. NO.

HOLE

O600 14 002 0001

1

O600 14 002 0002

2

O600 14 002 0003

3

O600 14 002 0004

4



## Threaded Rod (M6)

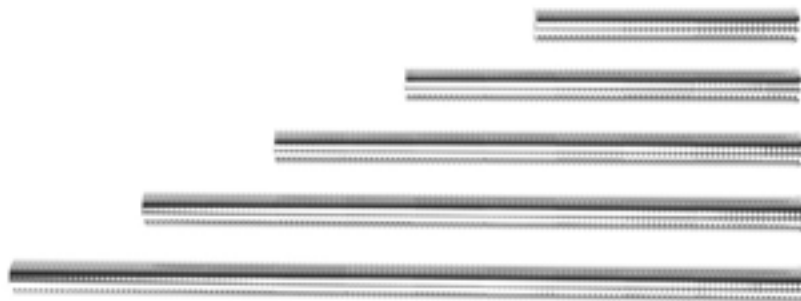

SS

LENGTH  
(mm)

O600 10 050 0050

50

O600 10 050 0075

75

O600 10 050 0100

100

O600 10 050 0115

115

O600 10 050 0125

125

O600 10 050 0150

150

O600 10 050 0175

175

O600 10 050 0200

200

O600 10 050 0250

250

O600 10 050 0300

300

## Hybrid Fixator Extension Plate

SS

O600 11 050 2251





# ADULT CIRCULAR EXTERNAL FIXATORS

---

product  
group



## Half Ring



REF. NO.	DIA. (mm)
O600 10 120 0080	80
O600 10 120 0100	100
O600 10 120 0120	120
O600 10 120 0130	130
O600 10 120 0140	140
O600 10 120 0150	150
O600 10 120 0160	160
O600 10 120 0170	170
O600 10 120 0180	180
O600 10 120 0200	200
O600 10 120 0220	220

## 5/8 C Ring



REF. NO.	DIA. (mm)
O600 10 150 0080	80
O600 10 150 0100	100
O600 10 150 0120	120
O600 10 150 0140	140
O600 10 150 0150	150
O600 10 150 0160	160
O600 10 150 0170	170
O600 10 150 0180	180
O600 10 150 0200	200
O600 10 150 0220	220

## Foot Ring



REF. NO.	DIA. (mm)
O600 29 120 0220	80
O600 29 120 0100	100
O600 29 120 0120	120
O600 29 120 0140	140
O600 29 120 0160	160



## Femoral Arch



ALUMINIUM	SS	ANGLE / DIA. (mm)
O601 10 160 0090	O601 11 160 0090	90° / 160
O601 10 180 0090	O601 11 180 0090	90° / 180
O601 10 200 0090	O601 11 200 0090	90° / 200
O601 10 160 0120	O601 11 160 0120	120° / 160
O601 10 180 0120	O601 11 180 0120	120° / 180
O601 10 200 0120	O601 11 200 0120	120° / 200

## Multiple Pin Fixation Clamp

SS

O601 10 013 0000  
O601 10 013 0001  
O601 10 013 0002  
O601 10 013 0003



## Oblique Support Connector

SS

LENGTH (mm)

O600 10 080 0000 30  
O600 10 080 0001 58  
O600 10 080 0002 82



## Telescopic Rod



SS

LENGTH (mm)

O600 10 071 0100 100  
O600 10 071 0125 125  
O600 10 071 0150 150  
O600 10 071 0175 175  
O600 10 071 0215 215

## Adjustable Clamp

SS

O600 10 001 0001



## Double Female Hinge

SS

O601 10 099 0010



## Male Half Hinge

SS

O601 10 099 0015



## Female Half Hinge

SS

O601 10 099 0020



## Cannulated Bolt

SS

O600 10 090 0001



## Slotted Bolt

SS

O600 10 091 0000



## Half Pin Universal Retaining Bolt

SS

O600 10 099 0001



## Single Pin Fixation Bolt

SS

O601 10 010 0000



## Female Support

SS

HOLES

LENGTH (mm)

O600 10 065 0000

1

23

O600 10 065 0002

2

32

O600 10 065 0003

3

41



## Male Support

SS

HOLES

LENGTH (mm)

O600 10 060 0112

1

12

O600 10 060 0222

2

42

O600 10 060 0332

3

51



## Connection Bolt (M6)

SS

LENGTH (mm)

O600 10 020 0016

16

O600 10 020 0020

20

O600 10 020 0025

25

O600 10 020 0030

30

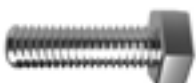

## Connecting Plate

SS

HOLES

LENGTH (mm)

O600 10 050 2035

2

41

O600 10 050 3050

3

51

O600 10 050 4060

4

61

O600 10 050 5070

5

71

O600 10 050 6085

6

81

O600 10 050 7100

7

91

O600 10 050 8110

8

101



## Connecting Plate with Threaded End



SS	HOLES	LENGTH (mm)
O600 11 050 2131	5	131
O600 11 050 2171	7	171
O600 11 050 2211	9	211

## 90 ° Angular Plate



SS	HOLES	LENGTH (mm)
O600 14 000 1150	2	50
O600 14 000 1175	4	75

## Twisted Plate

SS	HOLES	LENGTH (mm)
O600 10 054 0046	2	50
O600 10 054 0067	3	70
O600 10 054 0088	4	90



## Universal Hinge

SS
O601 15 000 0000



## Curved Plate

ALUMINIUM
O601 15 000 0020



## Square Socket

SS	HOLES
O600 14 002 0001	1
O600 14 002 0002	2
O600 14 002 0003	3
O600 14 002 0004	4



## Square Socket Centering Sleeve

SS	DIA. (mm)
O600 14 002 0605	6



## Washer

SS	DIA. (mm)
O600 10 030 0012	12
O600 10 030 0013	14



Oval Washer

SS	DIA. (mm)
O600 10 031 0012	12



Conical Washer

SS
O600 10 110 0001



Star Washer

SS
O600 10 032 0000



Nut M6

SS
O600 10 021 0000



Slotted Washer

SS
O600 10 034 0000



Threaded Rod (M6)

SS	LENGTH (mm)
O600 10 050 0050	50
O600 10 050 0075	75
O600 10 050 0100	100
O600 10 050 0115	115
O600 10 050 0125	125
O600 10 050 0150	150
O600 10 050 0175	175
O600 10 050 0200	200
O600 10 050 0250	250
O600 10 050 0300	300
O600 10 050 0350	350
O600 10 050 0400	400

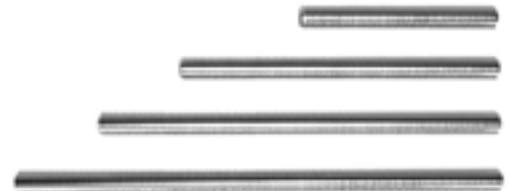

Lengthening Rod (M6)

REF. NO.	LENGTH (mm)
O600 10 011 0060	60
O600 10 011 0080	80
O600 10 011 0100	100
O600 10 011 0120	120
O600 10 011 0150	150
O600 10 011 0200	200



Slotted Rod (M6)

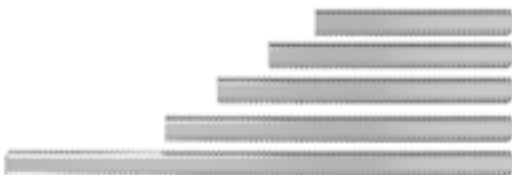

SS	LENGTH (mm)
O600 08 011 0040	40
O600 08 011 0050	50
O600 08 011 0060	60
O600 08 011 0070	70
O600 08 011 0100	100

## Trocar Pointed Wire



SS	DIA. x LENGTH (mm)
O600 10 100 1830	1,8X300
O600 10 100 1840	1,8X400
O600 10 100 2030	2,0X300
O600 10 100 2040	2,0X400

## Bayonet Pointed Wire



SS	DIA. x LENGTH (mm)
O600 10 139 1830	1,8X300
O600 10 139 1840	1,8X400
O600 10 139 2030	2,0X300
O600 10 139 2040	2,0X400

## Olive Wire



SS	DIA. x LENGTH (mm)
O600 10 188 1830	1,8X300
O600 10 188 1840	1,8X400
O600 10 188 2030	2,0X300
O600 10 188 2040	2,0X400

## Hybrid External Fixator (For adaptation to External Circular Fixation System)



REF. NO.	TYPE	LENGTH (mm)	Pin / Screw to be used
O600 25 001 0025	MEDIUM	230	Ø (2,5 / 3,0 / 3,5 / 4,0 mm)
O600 11 014 0005	LONG	250	Ø (4,5 / 5,0 / 5,5 / 6,0 mm)



# PEDIATRIC CIRCULAR EXTERNAL FIXATORS

---

product  
group



## Pediatric Half Ring



ALUMINIUM	DIA. (mm)
O600 11 121 0070	Ø 70
O600 11 121 0080	Ø 80
O600 11 121 0090	Ø 90
O600 11 121 0100	Ø 100
O600 11 121 0110	Ø 110
O600 11 121 0120	Ø 120

## Pediatric 5/8 C Ring



ALUMINIUM	DIA. (mm)
O600 11 151 0070	Ø 70
O600 11 151 0080	Ø 80
O600 11 151 0090	Ø 90
O600 11 151 0100	Ø 100
O600 11 151 0110	Ø 110
O600 11 151 0120	Ø 120

## Pediatric Femoral Arch



ALUMINIUM	ANGLE	DIA. (mm)
O601 11 090 0090	90°	90
O601 11 110 0090	90°	110
O601 11 090 0120	120°	90
O601 11 110 0120	120°	110

## Pediatric Adjustable Clamp

SS  
O600 11 002 0002



## Pediatric Multiple Pin Fixation Clamp

SS  
O601 11 014 0000



## Pediatric Slotted Bolt

SS  
O600 11 091 0000



## Pediatric Oblique Support Connector

SS	LENGTH (mm)
O600 11 080 0000	25
O600 11 080 0001	50
O600 11 080 0002	75



## Pediatric Cannulated Bolt

SS  
O600 11 090 0000



## Pediatric Telescopic Rod

SS  
O600 11 072 0001



## Pediatric Half Pin Universal Retaining Bolt

SS  
O600 11 099 0001



## Pediatric Male Half Hinge

SS  
O601 11 099 0015



## Pediatric Female Half Hinge

SS  
O601 11 099 0020



## Pediatric Lengthening Rod

SS  
O601 11 001 0101



## Pediatric Double Female Hinge

SS  
O601 11 099 0010



## Pediatric Connecting Plate

SS	HOLES	LENGTH (mm)
O600 11 050 2035	2	25
O600 11 050 3050	3	45
O600 11 050 4060	4	55
O600 11 050 5070	5	65





Pediatric Universal Hinge

SS

O601 16 000 0000



Pediatric Star Washer

SS

O600 11 032 0000



Pediatric Nut (M5)

SS

O600 11 021 0000



Pediatric Oval Washer

SS

O600 11 031 0101



Pediatric Washer

SS

O600 11 030 0101



Pediatric Curved Plate

ALUMINIUM

O601 16 000 0020



Pediatric Slotted Washer

SS

O600 11 034 0000



Pediatric Square Socket

SS

HOLES

O600 16 002 0001

1

O600 16 002 0002

2

O600 16 002 0003

3

O600 16 002 0004

4



Pediatric Square Socket Centering Sleeve

SS

DIA. (mm)

O600 14 002 0305

3

O600 14 002 0405

4

O600 14 002 0505

5



Pediatric Male Support

SS

HOLES

LENGTH (mm)

O600 11 060 0112

1

31,5

O600 11 060 0222

2

40,5

O600 11 060 0332

3

49,5



## Pediatric Connection Bolt (M5)

REF. NO.	LENGTH (mm)
O600 11 020 0012	12
O600 11 020 0016	16



## Pediatric 90 ° Angular Plate

REF. NO.	HOLES	LENGTH (mm)
O600 14 001 1150	2	41
O600 14 001 1175	4	65



## Twisted Plate

REF. NO.	HOLES	LENGTH (mm)
O600 11 054 0046	2	45
O600 11 054 0067	3	63
O600 11 054 0088	4	81



## Pediatric Female Support

REF. NO.	HOLE	LENGTH (mm)
O600 11 065 0000	1	22,5
O600 11 065 0002	2	31,5
O600 11 065 0003	3	40,5



## Pediatric Threaded Socket

REF. NO.	LENGTH (mm)
O600 16 001 1115	15
O600 16 001 1125	25



## Pediatric Trocar Pointed Wire



SS	DIA. x LENGTH (mm)
O600 11 100 1520	1,5X200
O600 11 100 1525	1,5X250
O600 11 100 1820	1,8X200
O600 11 100 1825	1,8X250

## Pediatric Bayonet Pointed Wire



REF. NO.	DIA. x LENGTH (mm)
O600 11 135 1520	1,5X200
O600 11 135 1525	1,5X250
O600 11 135 1820	1,8X200
O600 11 135 1825	1,8X250

## Pediatric Olive Wire



REF. NO.	DIA. x LENGTH (mm)
O600 11 188 1520	1,5X200
O600 11 188 1525	1,5X250
O600 11 188 1820	1,8X200
O600 11 188 1825	1,8X250

## Pediatric Threaded Rod (M5) Bolt

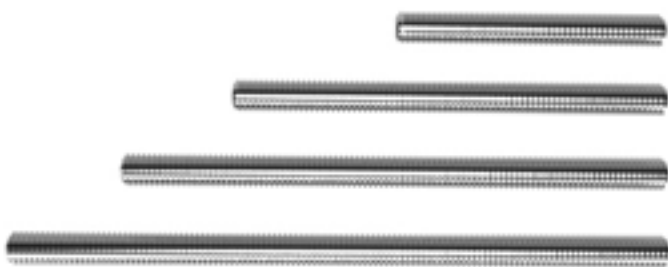

REF. NO.	LENGTH (mm)
O600 11 050 0040	40
O600 11 050 0050	50
O600 11 050 0060	60
O600 11 050 0080	80
O600 11 050 0090	90
O600 11 050 0100	100
O600 11 050 0120	120
O600 11 050 0150	150
O600 11 050 0180	180



# WIRES, PINS, & STAPLES

---

product  
group



## Kirschner Wires with Trocar Point



SS	DIA. (mm)	SS	DIA. (mm)
O100 03 070 0620	0,6	O100 03 070 2028	2,0
O100 03 070 0825	0,8	O100 03 070 2225	2,2
O100 03 070 0925	0,9	O100 03 070 2510	2,5
O100 03 070 1025	1,0	O100 03 070 2810	2,8
O100 03 070 1210	1,2	O100 03 070 3010	3,0
O100 03 070 1510	1,4	O100 03 070 3225	3,2
O100 03 070 1525	1,5	O100 03 070 3510	3,5
O100 03 070 1625	1,6	O100 03 070 4010	4,0
O100 03 070 1810	1,8	O100 03 070 4529	4,5
		O100 03 070 5025	5,0

## Kirschner Wires with Double Trocar Point



SS	DIA. (mm)	SS	DIA. (mm)
O100 03 073 0625	0,6	O100 03 073 2012	2,0
O100 03 073 0812	0,8	O100 03 073 2212	2,2
O100 03 073 0925	0,9	O100 03 073 2510	2,5
O100 03 073 1012	1,0	O100 03 073 3015	2,8
O100 03 073 1212	1,2	O100 03 073 3010	3,0
O100 03 073 1429	1,4	O100 03 073 3229	3,2
O100 03 073 1512	1,5	O100 03 073 3510	3,5
O100 03 073 1629	1,6	O100 03 073 4010	4,0
O100 03 073 1812	1,8	O100 03 073 6032	4,5
		O100 03 073 5020	5,0

## Threaded Kirschner Wires with Trocar Point



SS	DIA. (mm)
O100 03 071 0020	2,0
O100 03 071 0025	2,5
O100 03 071 0030	3,0
O100 03 071 0032	3,2
O100 03 071 0035	3,5
O100 03 071 0040	4,0

## Cerclage Wire



SS	DIA. X LENGTH (mm)	SS	DIA. X LENGTH (mm)
O400 03 011 0329	0,3X5000	O400 03 011 1019	1,0X5000
O400 03 011 0427	0,4X5000	O400 03 011 1218	1,2X5000
O400 03 011 0525	0,5X5000	O400 03 011 1517	1,5X5000
O400 03 011 0623	0,6X5000	O400 03 011 1826	1,8X5000
O400 03 011 0722	0,7X5000	O400 03 011 2027	2,0X5000
O400 03 011 0821	0,8X5000	O400 03 011 2328	2,3X5000
O400 03 011 0920	0,9X5000	O400 03 011 2529	2,5X5000

## Steinmann Pin with Trocar Point



DIA. (mm)	SS
1,8	O100 03 050 1829
2,0	O100 03 050 2029
2,5	O100 03 050 2529
3,0	O100 03 050 3012
3,5	O100 03 050 3512
4,0	O100 03 050 4012
4,5	O100 03 050 4512
5,0	O100 03 050 5012
6,0	O100 03 050 6012

## Steinmann Pins with Central Threaded



SS	DIA. (mm)	THREAD LENGTH (mm)	SS	DIA. (mm)	THREAD LENGTH (mm)
O100 03 051 3230	3,0	60	O100 03 051 5230	5,0	60
O100 03 051 4230	4,0	60	O100 03 051 5524	5,5	60
O100 03 051 4523	4,5	60	O100 03 050 6018	6,0	60

## Schanz Screw



SS	DIA. (mm)
O100 03 090 5012	1,5
O100 03 090 6026	2,0
O100 03 091 6020	2,5
O100 03 090 3115	3,0
O100 03 090 6030	3,5
O100 03 090 4011	4,0
O100 03 090 4517	4,5
O100 03 090 5013	5,0
O100 03 090 5515	5,5
O100 03 090 6012	6,0

## Schanz Conical Screw (Cortical)



SS	DIA. x LENGTH (mm)
O600 11 110 0130	6,0X130
O600 11 110 0115	6,0X150
O600 11 110 0160	6,0X160
O600 11 110 0180	6,0X180
O600 11 110 0200	6,0X200
O600 11 110 0220	6,0X220

## Schanz Screw Cancellous



SS	DIA. x LENGTH (mm)
O600 11 111 0150	6,0X150
O600 11 111 0160	6,0X160
O600 11 111 0180	6,0X180
O600 11 111 0200	6,0X200
O600 11 111 0220	6,0X220

## Calibrated Self - Tapping Schanz Screw



SS	DIA. (mm)
O600 13 110 4018	4,0
O600 13 110 5013	5,0
O600 13 110 0160	6,0

## Rush Type Intramedullary Pin



SS	DIA. (mm)
O100 04 051 2016	2,0
O100 04 051 2518	2,5
O100 04 051 3016	3,0
O100 04 051 3218	3,2
O100 04 051 3220	3,5
O100 04 051 4016	4,0
O100 04 051 4514	4,5
O100 04 051 5016	5,0
O100 04 051 5522	5,5
O100 04 051 6020	6,0
O100 04 051 7025	7,0

## Pelvic Traction Screw



SS	DIA. (mm)
O602 00 010 3232	3,2
O602 00 010 4545	4,5
O602 00 010 8016	8,0
O602 00 010 8020	8,0



Epiphyseal Staples Stainless Steel

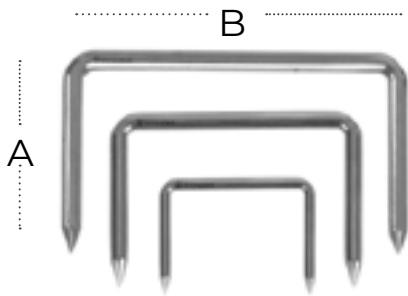

SS	A LENGTH (mm)	B LENGTH (mm)	DIA. (mm)
O100 03 110 0015	19	16	1,5
O100 03 110 0020	19	22	2,0
O100 03 110 0025	19	26	2,5

Coventry Staples Stainless Steel

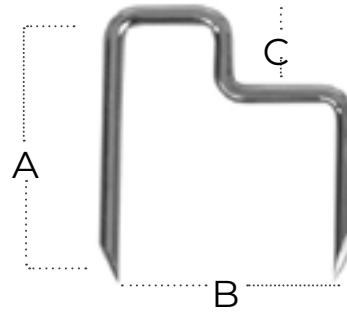

SS	A LENGTH (mm)	B LENGTH (mm)	C LENGTH (mm)	DIA. (mm)
O100 03 111 0140	33	25	14	2,5
O100 03 111 0050	33	25	10	2,5
O100 03 111 0100	33	25	5	2,5

Thorny Epiphyseal Staples Titanium

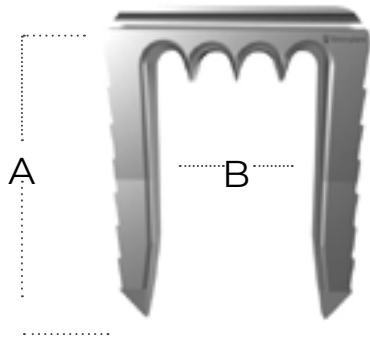

Ti	A LENGTH (mm)	B LENGTH (mm)
O100 03 115 0650	20	6,5
O100 03 115 0800	20	8
O100 03 115 0115	20	10
O100 03 115 0150	20	15

Thorny Coventry Staples Titanium

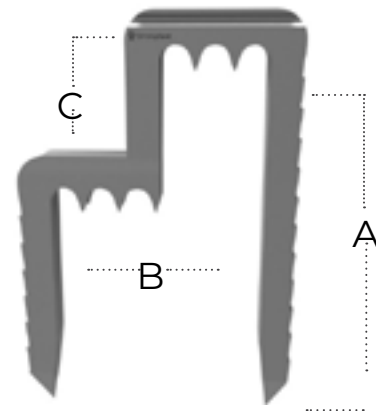

Ti	A LENGTH (mm)	B LENGTH (mm)	C LENGTH (mm)
O100 03 111 0050	33	25	5
O100 03 111 0100	33	25	10
O100 03 111 0140	33	25	14
O100 03 111 0200	33	25	16

Thorny Washer



SS
O600 12 032 0000

\* DIA. Means DIAMETER

## Tibial Bolt



SS	DIA. (mm)
O100 03 135 1000	3
O100 03 130 0800	4

## Knowless Hip Pin



SS	DIA. (mm)
O100 14 051 4070	3,0
O100 14 051 8075	3,2
O100 14 051 5060	4,0
O100 14 051 4585	4,5
O100 14 051 5016	5,0

## Drill Bit



SS	DIA. (mm)
O101 03 090 0020	Ø 1,2
O101 03 091 0027	Ø 1,5
O101 03 091 0020	Ø 1,8
O101 03 090 2012	Ø 2,0
O101 03 090 2212	Ø 2,2
O101 03 091 0022	Ø 2,5
O101 03 090 2712	Ø 2,7
O101 03 092 0030	Ø 3,0
O101 03 090 3212	Ø 3,2
O101 03 090 3512	Ø 3,5
O101 03 090 0045	Ø 3,7
O101 03 092 0040	Ø 4,0
O101 03 090 4512	Ø 4,5
O101 03 090 4028	Ø 5,0
O101 03 090 0032	Ø 5,5
O101 03 091 0045	Ø 6,0

## Gigli Saw



SS	LENGTH (mm)
O400 09 111 1030	300
O400 09 111 1040	400
O400 09 111 1050	500
O400 09 111 1060	600



# PRODUCTGROUPS

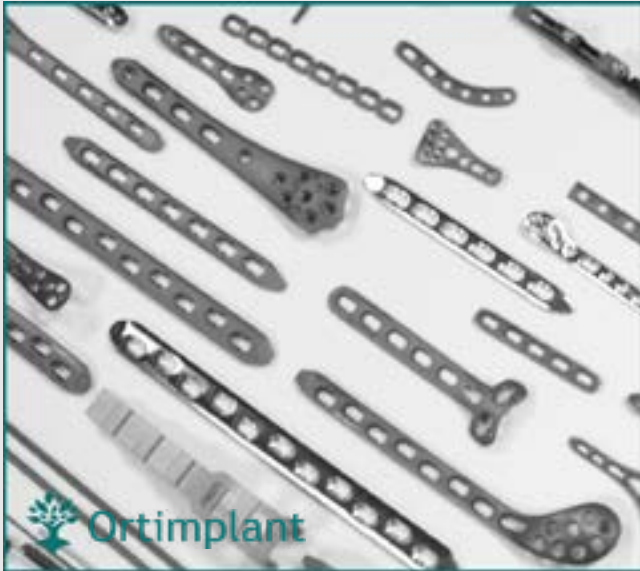

TRAUMA PRODUCTS

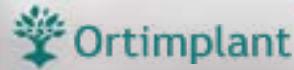
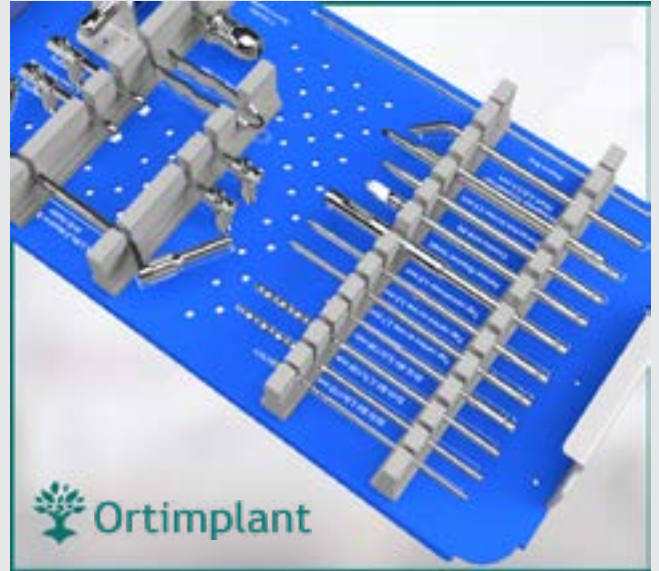

TRAUMA INSTRUMENT SETS

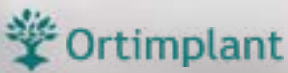

ORTHOPAEDIC SURGICAL INSTRUMENTS

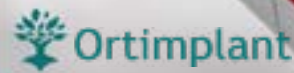

STERILIZATION CONTAINERS

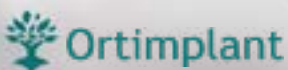
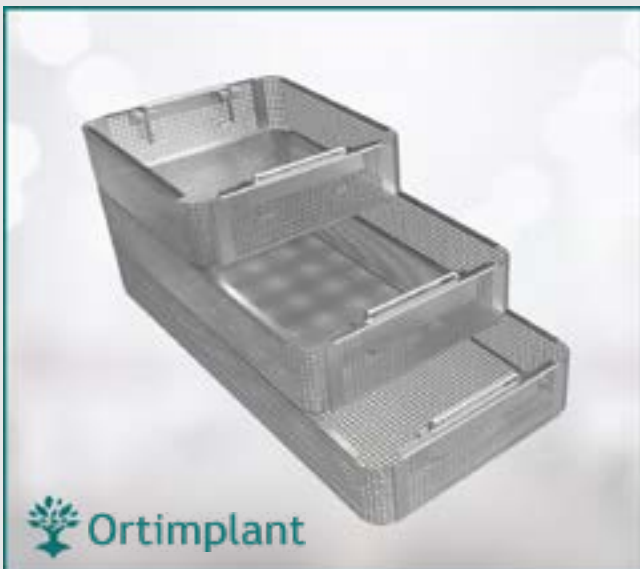

STERILIZATION BASKETS

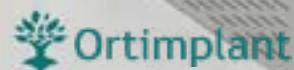

ORTHOPAEDIC STERILIZATION CONTAINERS

# ortimplant

[www.ortimplant.com](http://www.ortimplant.com)

Ortimplant Samsun  
Kirazlık Mahallesi, 1034. Cadde No:14 Tekkek y  
SAMSUN / TURKEY  
info@ortimplant.com

Workshop  
Organize Sanayi Sitesi M.Erdođan Cebeci  
Bulvarı No:34 Tekkek y / SAMSUN / TURKEY

Tel : +90 362 266 97 28  
Fax : +90 362 266 58 72  
info@ortimplant.com

“  
Quality  
in  
Health”